



# Low Rise Multi-Residential Intertenancy Walls

Design and Installation Guide

# Contents

This Design Guide has been prepared as a source of information to provide general guidance to consultants – and in no way replaces the services of the professional consultant and relevant engineers designing the project.

It is the responsibility of the architectural designer and engineering parties to ensure that the details in this Design and Installation Guide are appropriate for the intended application.

The recommendations of this guide are formulated along the lines of good building practice, but are not intended to be an exhaustive statement of all relevant data.

## **Introduction 3**

### **1. Design and selection details 6**

- Typical applications 6
- Structural provisions 9
- Design and detailing considerations 10
- System components 11

### **2. System performance 13**

- Regulatory issues 13
- Sound transmission and insulation 14
- Fire resistance performance 16

### **3. Installation detail 17**

- Installation guidelines 17
- Construction for the PowerPanel<sup>XL</sup> Intertency discontinuous Wall Systems 18
- Junction details for the PowerPanel<sup>XL</sup> Intertency discontinuous Wall Systems 22
- Construction for the PowerPanel<sup>XL</sup> Intertency non-discontinuous Wall Systems 24
- Junction details for the PowerPanel<sup>XL</sup> Intertency non-discontinuous Wall Systems 28

### **4. Handling, storage and responsibility 29**

- Delivery and storage 29
- Hebel Hoist 30
- Panel handling 31
- Design detailing and performance responsibilities 32

### **Appendices 33**

- Appendix A: Hebel PowerPanel<sup>XL</sup> material properties and Assessment Methods 33
- Appendix B: Architectural Specification 34
- Appendix C: PowerPanel<sup>XL</sup> System Descriptions 35

# Better buildings are constructed with Hebel



Hebel is a lightweight steel-reinforced Autoclave Aerated Concrete (AAC) that has been used in Europe for over 70 years and here in Australia for over 20 years.

## **Hebel. A high-performance lightweight concrete panel system.**

Hebel is the innovative and sustainable, high-performance and lightweight concrete panel system of the future – available today.

Easy to install, strong and solid, Hebel steel reinforced panels are highly versatile and can be used on all sites to provide extremely solid, safe and highly secure internal walls with high levels of sound resistance and absorption. They are not affected by dampness when suitably constructed.

Hebel systems can achieve (and often exceed) BCA requirements and are extremely fire-resistant with thermal absorbing properties that assist in improved energy ratings for the building and have been independently certified as meeting the requirements of Good Environmental Choice Australia ([www.geca.org.au](http://www.geca.org.au)).

## **Hebel. Proven, scientifically tested and trusted by leading builders.**

The Hebel system has a solid track record of trusted performance and reliability characteristics that make it the accepted industry standard in internal wall systems.

Building with Hebel means simpler construction methods, delivers faster construction timetables and lowers risk of non-compliance to the BCA.

## **Proven in the market and backed by CSR**

Hebel products and systems are developed in Australia by CSR Building Products Limited. With CSR you can depend on the product quality, technical expertise, warranty and stock supplies of Hebel products and systems.



HEB - 2010  
Environmentally Innovative Products

# Hebel. Better to build with...

At the heart of the Hebel system is the Hebel PowerPanel<sup>XL</sup> panel – a 75mm thick, steel reinforced building panel made from AAC (Autoclaved Aerated Concrete) supplied in lengths of 2400mm to 3300mm for standard widths of 600mm.

The unique Hebel attributes are best summarised with the Hebel 'tick' below:

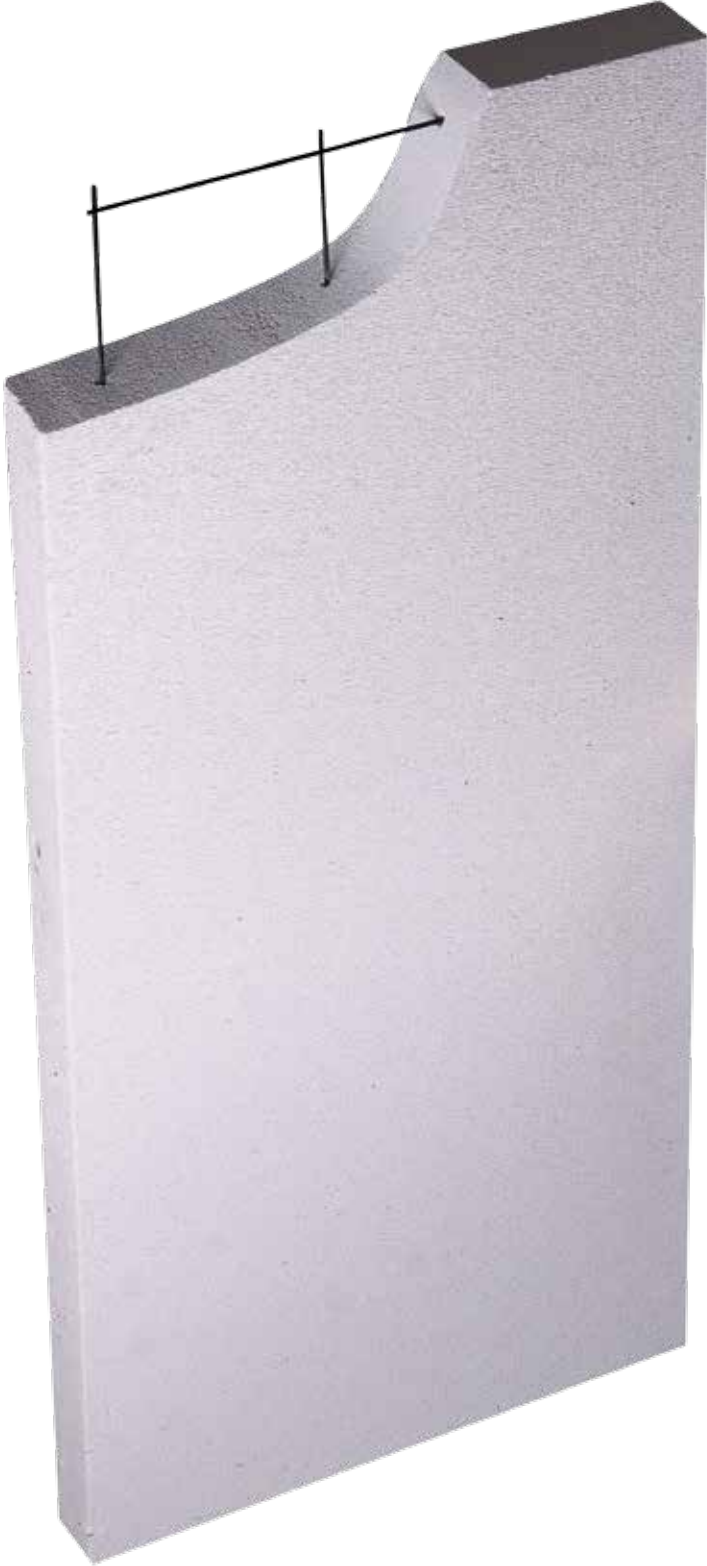



### Fastest masonry Intertency Wall System

PowerPanel<sup>XL</sup> Intertency Walls are fast to construct and require significantly less labour compared to traditional masonry construction techniques. Building with

Hebel means a cleaner, safer work area during construction and less clean-up at completion of building.



### Highly fire resistant for peace of mind and added security

Hebel is non-combustible and renowned for its highly fire resistant properties. PowerPanel<sup>XL</sup> Intertency Wall Systems have been tested at CSIRO and achieve a FRL (Fire Resistance Level) of up to 90 minutes.



### Lightweight yet solid and tough as concrete

Lightweight Hebel PowerPanel<sup>XL</sup> panels can be easily installed by a crew of 2 or 3. PowerPanel<sup>XL</sup> Intertency Walls also

provide a high degree of security with solid, steel reinforced PowerPanel<sup>XL</sup> panels between units. The ultimate masonry "party wall" system.



### Sustainability for a better world in the long term starts today

Hebel delivers a diverse number of environmental benefits over brick and concrete. In an independent Life Cycle Assessment (the leading methodology

used to quantify the environmental impacts of a product's entire life) undertaken by Good Environment Choice Australia, in accordance with international standard ISO 14 024, Hebel was found to have clear environmental benefits across all key environmental criteria.

To be awarded the label, products must have a 30% lower impact than alternatives. Hebel uses 61% and 64% less embodied energy and 64% and 55% less greenhouse gas emissions than the comparative products, concrete and brick veneer.

As environmental consciousness and social responsibility increases, Hebel is striving to exceed further to set new sustainability standards in building materials and residential living.



### A comforting thought for a comfortable living environment

Hebel's unique AAC construction provides superior insulation qualities for a masonry product. The unique

combination of thermal resistance along with thermal mass, make building with Hebel a smart choice for meeting Australia's increasing building efficiency regulations.

For unit owners, the thermal efficiencies of Hebel reduce the reliance on heating and cooling appliances – the combined effects of using a heater less in winter and fans or air conditioning less in summer can have a big impact on rising energy costs.



### A sound reason for better acoustic qualities

Hebel pioneered the introduction of lightweight wall panels providing acoustic performance levels at or above  $R_w + C_{tr} = 50$  in low rise multi-residential

buildings. BCA acoustic compliance is simple and easy to achieve with a system that has the benefits of lightweight construction with steel reinforced masonry between the walls.

# ...for all the best reasons

With the attributes and benefits shown above this innovative and versatile masonry product provides confidence that Hebel is ideal for all Intertency Walls as detailed throughout the remainder of this Design and Installation Guide.

# 1.1 Typical Applications

PowerPanel<sup>XL</sup> Intertency Wall Systems detailed in this guide are loadbearing or non-loadbearing Intertency wall solutions for low rise multi-residential framed construction. These wall configurations consist of Hebel (non-load bearing) PowerPanel<sup>XL</sup> panels installed vertically, and secured to the structural loadbearing framing.

A distinct difference between the systems is the PowerPanel<sup>XL</sup> panel to framing connection methods and the resulting acoustic performance qualities.

PowerPanel<sup>XL</sup> Intertency Discontinuous Wall Systems utilises an aluminium bracket system. The bracket system provides the wall with a 'Discontinuous Construction' rating. PowerPanel<sup>XL</sup> Intertency Non-discontinuous Wall Systems offers a Top Hat connection where the PowerPanel<sup>XL</sup> panel is secured to the framing with horizontal steel Top Hats.

*Detail 1.1 PowerPanel<sup>XL</sup> Intertency Discontinuous Wall Systems*

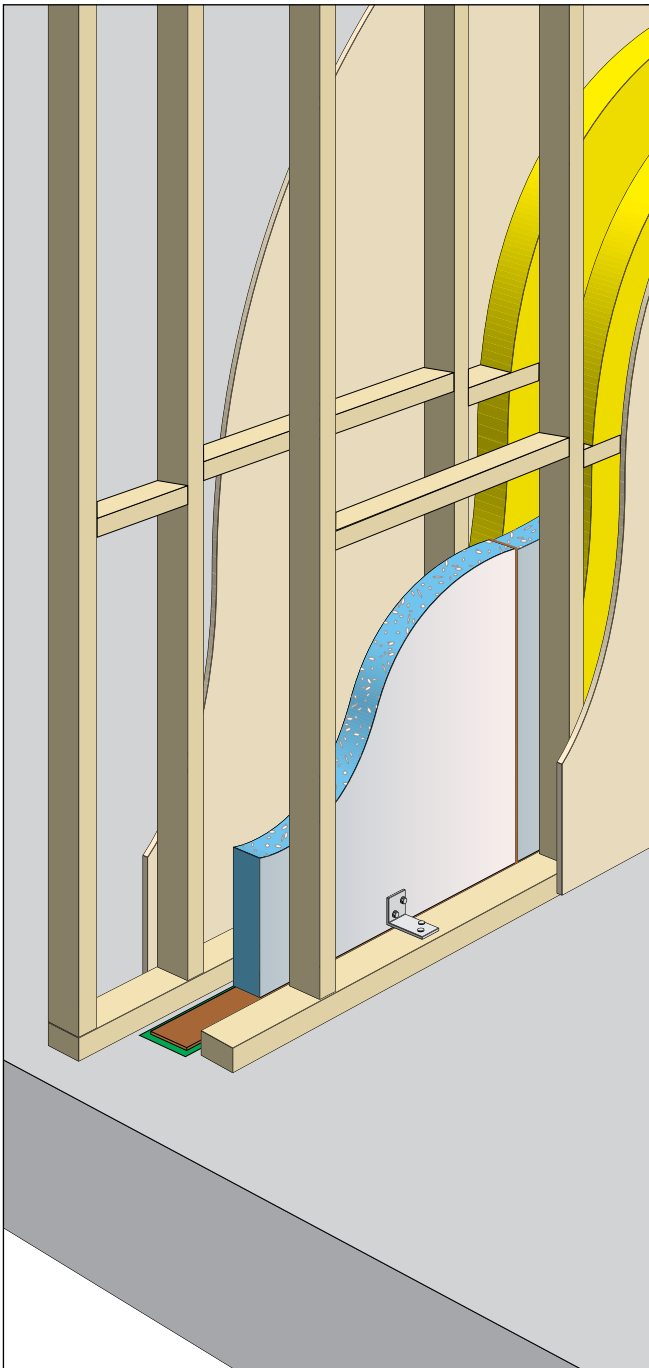

*Detail 1.2 PowerPanel<sup>XL</sup> Intertency Non-discontinuous Wall Systems*

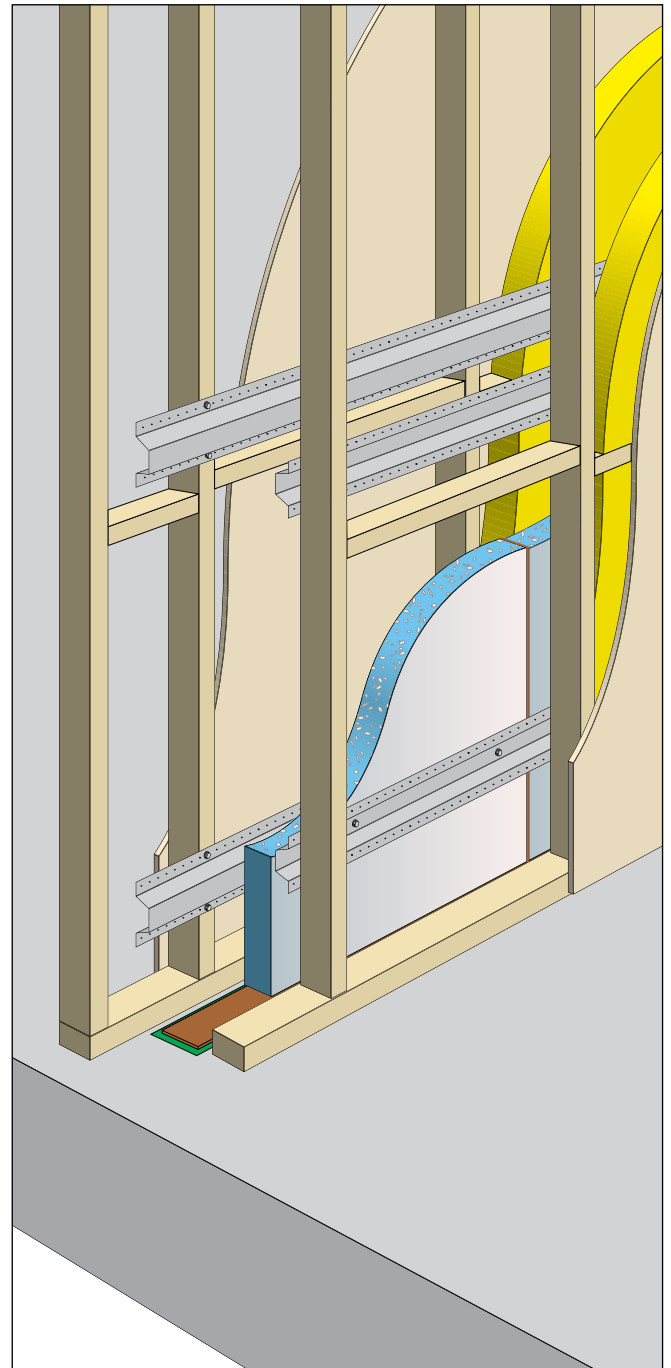

# Discontinuous Construction

**Recommended for:** Discontinuous construction using brackets for superior acoustics

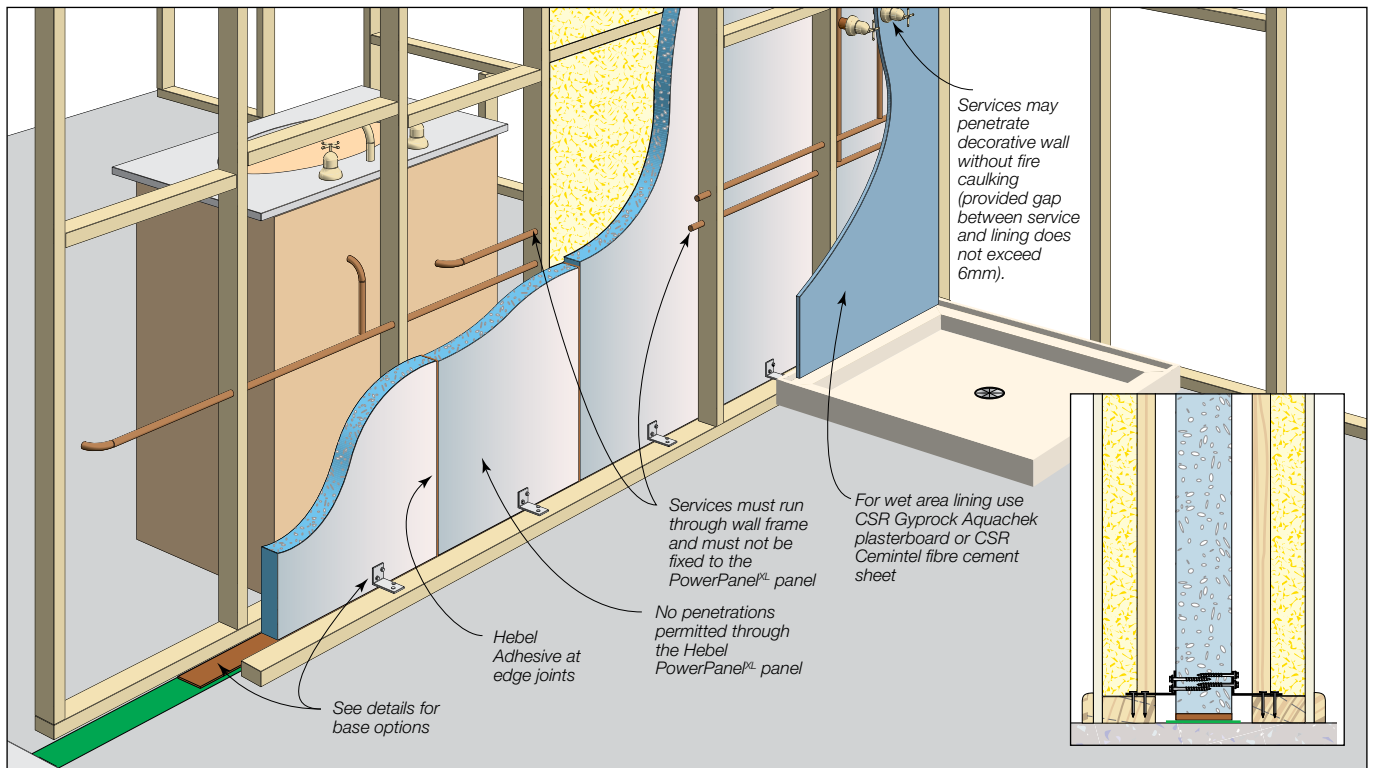

HEB CODE	WALL THICKNESS Stud Depth		FRL PP (XL)	$R_w/R_w+C_{tr}$ Stud Depth		CAVITY INSULATION	WALL LINING BOTH SIDES
	70mm	90mm		70mm	90mm		
HEB1900	275mm	315mm	-90/90	42/34	44/35	NIL - both sides	• 1 x 10mm GYPROCK plasterboard CD*
HEB1901	275mm	315mm		61/51	63/54	90mm Bradford Comfortseal R2.0 - both sides	
HEB1902	275mm	315mm		60/50	62/52	Tontine <sup>^</sup> TSB4 (70mm) TB5 (90mm) - both sides	
HEB1903	281mm	321mm	-90/90	43/34	45/36	NIL - both sides	• 1 x 13mm GYPROCK plasterboard CD
HEB1904	281mm	321mm		64/52	67/55	90mm Bradford Comfortseal R2.0 - both sides	
HEB1905	281mm	321mm		63/50	66/53	Tontine <sup>^</sup> TSB4 (70mm) TB5 (90mm) - both sides	
HEB1906	281mm	321mm	-90/90	44/35	45/36	NIL - both sides	• 1 x 13mm GYPROCK SOUNDCEK
HEB1907	281mm	321mm		67/55	70/58	90mm Bradford Comfortseal R2.0 - both sides	
HEB1908	281mm	321mm		66/53	69/56	Tontine <sup>^</sup> TSB4 (70mm) TB5 (90mm) - both sides	
HEB1909	275mm	315mm	-90/90	43/34	45/36	NIL - both sides	• 1 x 10mm GYPROCK AQUACHEK
HEB1910	275mm	315mm		64/52	67/55	90mm Bradford Comfortseal R2.0 - both sides	
HEB1911	275mm	315mm		63/50	66/53	Tontine <sup>^</sup> TSB4 (70mm) TB5 (90mm) - both sides	
HEB1912	273mm	313mm	-90/90	44/35	45/36	NIL - both sides	• 1 x 9mm CEMINTEL fibre cement sheet
HEB1913	273mm	313mm		67/55	70/58	90mm Bradford Comfortseal R2.0 - both sides	
HEB1914	273mm	313mm		66/53	69/56	Tontine <sup>^</sup> TSB4 (70mm) TB5 (90mm) - both sides	

Note: \*Timber framing to be in accordance AS1684 or AS1720.1 requires studs at 450 mm maximum spacings and mid-height nogging for use of 10mm Gyprock Plasterboard wall linings (refer Acoustic Logic assessment 2010861.19/0504A/R1/TN). For steel framing, frames to be designed in accordance with AS3623 or AS4600.

<sup>^</sup> Autex or Polymax equivalent polyester insulation may be used.

1. Powerpanel<sup>XL</sup> Intertency Discontinuous Wall Systems has been assessed to comply with the BCA requirements for 'Discontinuous Construction' - BCA Vol. 2, clause 3.8.6.2 and clause 1.2.2(vi).

2. This table must be read in conjunction with all the information provided in this Design Guide, and acoustic opinion 2010861.19/0504A/R1/TN provided by Acoustic Logic and fire assessment WRFA 45771.10 provided by Exova Warringtonfire (Aust) Pty Ltd.

3. Selection of the most suitable Powerpanel XL Intertency Wall System should be undertaken with specialist consultant's advice.

4. 20mm separation between the frame and Hebel Powerpanel<sup>XL</sup> + aluminium bracket connection.

# Non-discontinuous Construction

**Recommended for:** Non-discontinuous construction using Top Hats for ease of installation

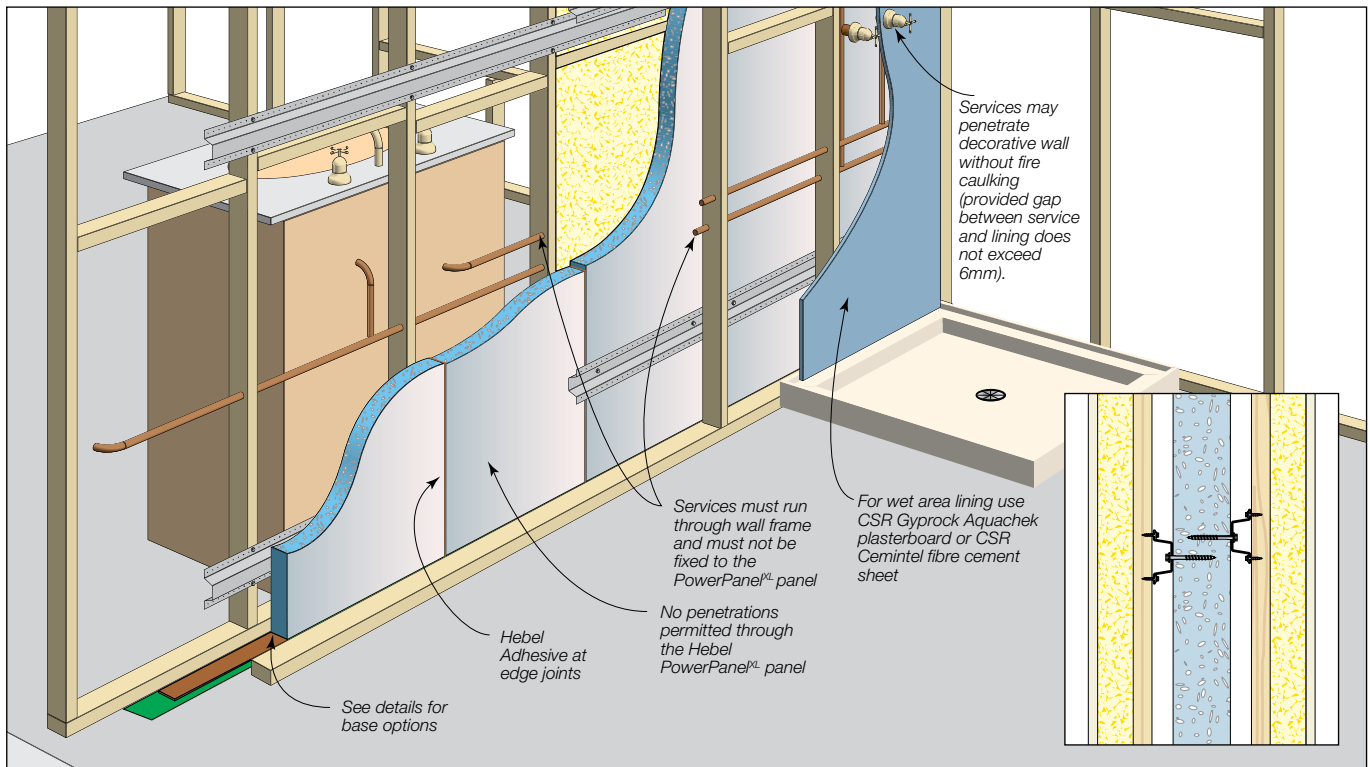

HEB CODE	WALL THICKNESS Stud Depth		FRL	R <sub>w</sub> /R <sub>w</sub> +C <sub>tr</sub> Stud Depth		CAVITY INSULATION	WALL LINING BOTH SIDES
	70mm	90mm		70mm	90mm		
HEB1915	285mm	325mm	-90/90 90/90/90	42/33	44/33	NIL - both sides	• 1 x 10mm GYPROCK plasterboard CD*
HEB1916	285mm	325mm		59/46	61/46	90mm Bradford Comfortseal R2.0 - both sides	
HEB1917	285mm	325mm		58/45	60/45	Tontine^ TSB4 (70mm) TB5 (90mm) - both sides	
HEB1918	291mm	331mm	-90/90 90/90/90	43/34	45/36	NIL - both sides	• 1 x 13mm GYPROCK plasterboard CD
HEB1919	291mm	331mm		61/47	62/48	90mm Bradford Comfortseal R2.0 - both sides	
HEB1920	291mm	331mm		60/45	61/46	Tontine^ TSB4 (70mm) TB5 (90mm) - both sides	
HEB1921	291mm	331mm	-90/90 90/90/90	44/35	45/36	NIL - both sides	• 1 x 13mm GYPROCK SOUNDCEK
HEB1922	291mm	331mm		58/49	59/50	90mm Bradford Comfortseal R2.0 - both sides	
HEB1923	291mm	331mm		57/47	58/48	Tontine^ TSB4 (70mm) TB5 (90mm) - both sides	
HEB1924	285mm	325mm	-90/90 90/90/90	43/34	45/36	NIL - both sides	• 1 x 10mm GYPROCK AQUACHEK
HEB1925	285mm	325mm		61/47	62/48	90mm Bradford Comfortseal R2.0 - both sides	
HEB1926	285mm	325mm		60/45	61/46	Tontine^ TSB4 (70mm) TB5 (90mm) - both sides	
HEB1927	283mm	323mm	-90/90 90/90/90	44/35	45/36	NIL - both sides	• 1 x 9mm CEMINTEL fibre cement sheet
HEB1928	283mm	323mm		58/49	59/50	90mm Bradford Comfortseal R2.0 - both sides	
HEB1929	283mm	323mm		57/47	58/48	Tontine^ TSB4 (70mm) TB5 (90mm) - both sides	

Note:\*\* Timber framing to be in accordance AS1684 or AS1720.1 requires studs at 450 mm maximum spacings and mid-height nogging for use of 10mm Gyprock Plasterboard wall linings (refer Acoustic Logic assessment 2010861.19/0904A/R2/TN). The Powerpanel Intertency Non-Discontinuous Wall System can no be used with steel framing.

^ Autex or Polymax equivalent polyester insulation may be used.

1. Powerpanel XL Intertency Non-Discontinuous Wall Systems does not comply with the BCA requirements for 'Discontinuous Construction' - BCA Vol. 2, clause 3.8.6.2 and clause 1.2.2(vi).

2. This table must be read in conjunction with all the information provided in this Design Guide, and acoustic opinion 2010861.19/0904A/R2/TN provided by Acoustic Logic and fire assessment WRF4 45772.10 provided by Exova Warringtonfire (Aust) Pty Ltd.

3. Selection of the most suitable Powerpanel XL Intertency Wall System should be undertaken with specialist consultant's advice.

4. 20-25mm seperation between the frame and Hebel Powerpanel XL + steel top hat connection.



# 1.2 Structural Provisions

## Structural Performance

The PowerPanel<sup>XL</sup> Intertency Wall Systems can be either a loadbearing or non-loadbearing wall. The Hebel PowerPanel<sup>XL</sup> panel within the wall system is non-loadbearing with the exception of self weight.

## Construction Loadings

During construction, the Hebel PowerPanel<sup>XL</sup> panel could be subject to wind loading. The builder shall provide the necessary temporary bracing of the panel until both structural frames are installed.

*Note: The screw connections may not be adequate to stabilise the panel against construction loadings.*

## Cutting of Hebel PowerPanel<sup>XL</sup>

The standard Hebel PowerPanel<sup>XL</sup> panel can be reduced in length by cutting 150mm maximum from each end, and to a minimum width of 270mm. All exposed steel reinforcement shall be liberally coated with the Fentak anti-corrosion coating available through Hebel.

## Wall Frame

The wall framing presented in this Design Guide for various wall systems are nominated for the acoustic and fire performance values. It is the designer's responsibility to determine an appropriate wall framing system to satisfy structural adequacy. Several items the designer must allow for are:

- lateral loadings
- wall height
- deflection limits
- offset distance (gap) from the panel
- building movement
- control joint locations

## Wall Height

The overall wall height limit is 12m for both PowerPanel<sup>XL</sup> Intertency Discontinuous Wall Systems and PowerPanel<sup>XL</sup> Intertency Non-discontinuous Wall Systems. The wall shall be constructed of Hebel PowerPanel<sup>XL</sup> of 3300mm maximum length. Walls constructed with PowerPanel<sup>XL</sup> panel lengths exceeding 3300mm will require custom designed panels. Contact Hebel for further information.

## Earthquake Loading

Earthquake loading has not been considered in this design guide. It is the designer's responsibility to ensure the connection system has adequate capacity to resist any imposed earthquake loading.

## Fixings

### Fasteners & Fixings

Most screw fixings are timber type, which is sufficient for penetrating the metal thicknesses outlined in this design guide. Connections that have larger metal thicknesses may require a metal type screw and will need to be designed and approved by the project engineer.

### Fixings – Deflection head track to substrate

The fixing to secure the angles and tracks to the concrete slab shall be capable of withstanding a shear load of 0.75kN. For high wind pressures during construction, the designer shall determine if mechanical fasteners are required:

- Drive pins and concrete nails (check size and suitability for fire rated situations with the manufacturer);
- 8mm diameter mechanical fasteners.

Table 1.4 outlines the connection type and requirements for constructing PowerPanel<sup>XL</sup> Intertency Discontinuous Wall Systems and PowerPanel<sup>XL</sup> Intertency Non-discontinuous Wall Systems detailed in this design guide.

Table 1.4 Fixings

Fixings for PowerPanelXL Intertenancy Discontinuous Wall Systems	Fixing Type	Number of Fixings and Spacing
Bottom angle/track to structure	M8 Dynabolt + 25 x 3mm load sharing washer	600mm max. centres
Bottom angle to PowerPanelXL panel	14-10 x 100mm hex head Type 17 screws	2 fixings per panel, 50mm min. from panel edge.
Track back-to-back	10-16 x 16mm wafer head screws	600mm max. centres
Aluminium bracket to timber frame	12-11 x 35mm hex head Type 17 screws	2 fixing per bracket
Aluminium bracket to steel frame	10-16 x 16mm hex head self-drilling screws	2 fixing per bracket
Aluminium bracket to PowerPanelXL panel	14-10 x 65mm hex head Type 17 screws	2 fixings per bracket
Gyprock™ Fyrchek to PowerPanelXL panel	10 x 50mm Bugle Head Laminating Screws	400mm centres maximum
Plasterboard to framing	Refer to the Gyprock™ Plasterboard Residential Installation Guide, GYP547	

Fixings for PowerPanelXL Intertenancy Non-discontinuous Wall Systems	Fixing Type	Number of Fixings and Spacing
Top Hat to timber stud	12-11 x 35mm hex head Type 17 screws	2 fixing per stud
Top Hat to PowerPanelXL panel	14-10 x 65mm hex head Type 17 screws	2 fixings per panel
Plasterboard to framing	Refer to the Gyprock™ Plasterboard Residential Installation Guide, GYP547	

## 1.3 Design & Detailing Considerations

### Control Joints

Control joints must be provided at a maximum of 6m spacing. Recommended control joint widths should be 10mm minimum between Hebel PowerPanelXL panels and another building component. Control joints must also be provided to coincide with any control joint in the main structure. Larger joint width maybe required to accommodate building movements, and these values shall be nominated by the designer. The Top Hat and back to back track must be discontinuous at a structural control joint.

### Wet Area Wall Construction

Wet area wall construction requires a system that enables services to be installed in a cavity. All plumbing should be acoustically treated as required by the BCA. All wet area walls shall be lined and waterproofed in accordance with



Australian standards and to BCA requirements. Gyprock™ Aquachek™ or Cemintel® Fibre Cement Wallboard are suitable lining materials for wet area applications.



### Non-Hebel Components used in Intertenancy Wall

Components, which are not manufactured by Hebel, such as Gyprock™ plasterboard, timber and steel stud wall frames, Bradford insulation and others must be designed, installed and handled in accordance with their manufacturer's guidelines and recommendations.

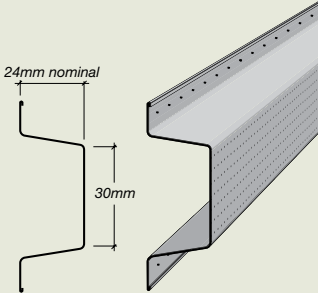
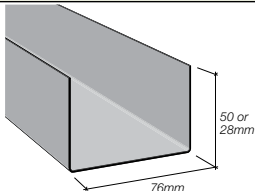
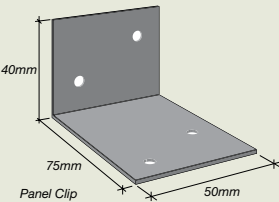
CSR Building Products Limited, guarantees only the products that are manufactured by CSR Building Products Limited, not the components, products or services supplied by others.

# 1.4 System Components

Product	Description	Supplied by CSR Hebel	
Hebel PowerPanel <sup>XL</sup> panel	The core component of PowerPanel <sup>XL</sup> Intertency Wall Systems is the 75mm thick, steel mesh reinforced Hebel PowerPanel <sup>XL</sup> panel. The panel is manufactured in a range of stock sizes with a nil edge profile, as detailed in Table 1.6	✓	
Hebel Perforated Steel Top Hat	In PowerPanel <sup>XL</sup> Intertency Non-discontinuous Wall Systems, the Top Hats (incorporating perforated flanges for ease of installation onto the wall frame) are used to fix the Hebel PowerPanel <sup>XL</sup> panel to the structural support framing.  In PowerPanel <sup>XL</sup> Intertency Discontinuous Wall Systems, the Top Hats are used to provide easy alignment of the panels during installation. The Top Hats are installed temporarily between the framing and panels, and <b>MUST BE</b> removed after the aluminium brackets are installed.	✓	
Hebel Deflection Head Track	For positioning and restraining the bottom and mid connection of the panels.	✓	
Hebel Wall Brackets	The brackets are proprietary components which enable the Hebel PowerPanel <sup>XL</sup> to be fixed to the wall frame. This provides a cavity space, which can result in increased acoustic insulation performance. The bracket is nominally 75 x 40 x 1.6mm x 50mm wide aluminium angle. Used in 75mm Hebel Intertency Discontinuous Wall Systems.	✓	
Hebel Adhesive	Hebel Adhesive is used for bonding the panels together at vertical joints. Supplied in 20kg bags.	✓	
Hebel Mortar	Hebel Mortar is used to provide a level base for panel installation as well as providing acoustic and fire protection at the base of the panels. Used in some PowerPanel <sup>XL</sup> Intertency Discontinuous & Non-discontinuous Wall base arrangements. Supplied in 20kg bags.	✓	

Product	Description	Supplied by CSR Hebel	
Hebel Mortar	Hebel Mortar is used to provide a level base for panel installation as well as providing acoustic and fire protection at the base of the panels. Used in some PowerPanel <sup>XL</sup> Intertency Discontinuous & Non-discontinuous Wall base arrangements. Supplied in 20kg bags.	✓	
Hebel anti-corrosion protection paint	To coat exposed reinforcement during cutting	✓	

Note: CSR has engineered and tested the PowerPanel<sup>XL</sup> Intertency Wall System to comply with the Building Code of Australia and relevant Australian Standards. It cannot guarantee products and accessories not specified and sold by CSR will perform to these standards. The Product Guarantee will only apply if all components used in the system are specified and sold by CSR or its agents.

## Bradford Insulation

PowerPanel<sup>XL</sup> Intertency Discontinuous and Non-discontinuous Wall Systems incorporate Bradford Insulation materials. Table 1.5 presents basic information on the glasswool and polyester insulation materials.

PowerPanel<sup>XL</sup> Intertency Wall Systems that use Bradford Glasswool insulation generally have a better acoustic performance than systems using Polyester insulation. Additional information regarding Bradford insulation materials is available from [www.bradfordinsulation.com.au](http://www.bradfordinsulation.com.au)



Table 1.5 Bradford Glasswool Insulation

Glasswool	Mass g/m <sup>2</sup>
50mm	540
75mm	810
90mm	940
110mm	1188

Table 1.6 Hebel PowerPanel<sup>XL</sup> Stock Sizes

Panel Type	Panel Weight (at 44kg/m <sup>2</sup> )			
	Length (mm)	Width (mm)		
		300	450	600
Standard	1200	-	-	31
	2400	31	47	63
	2550	-	-	67
	2700	35	53	71
	2800	-	-	73
	2850	-	-	74
	3000	39	59	78
	3300	-	-	86

Note: Average panel weight calculated at 45% moisture content.

## Gyprock™ Plasterboard

PowerPanel<sup>XL</sup> Intertency Discontinuous and Non-discontinuous Wall Systems incorporate Gyprock™ Plasterboard on both sides. The type, thickness and densities of plasterboard will be as per the specified wall requirements. Additional information is available from [www.gyprock.com.au](http://www.gyprock.com.au)

## Fire & Acoustic Sealant

To attain the specified FRL and/or Rw requirements, all perimeter gaps and penetrations must be carefully and completely sealed with a polyurethane fire and acoustic rated sealant installed to manufacturer's specifications.

## Backing Rod

Backing rod is used to enable correct filling of joints with sealant. It is recommended that backing rod be of open cell type to enable sealant to cure from behind. The diameter of backing rod must be appropriate for the width of the gap being filled.

## 2.1 Regulatory Issues

### Dwellings constructed side-by-side on a single allotment

Where it is proposed to construct single dwellings side-by-side on a single allotment the internal wall between dwellings is a fire separating wall as defined in the BCA. The fire separating wall must start from the ground level (top of concrete footings or top of floor slab) and achieve a 90/90/90 FRL if load bearing, or –/90/90 FRL if non-load bearing. The wall must go to the underside of a non-combustible roof covering and any gaps be filled with fire-resisting material as described in Detail 3.7.1.11 of Volume Two of the BCA.

### Dwellings constructed side-by-side on separate allotments

Where it is proposed to construct single dwellings side-by-side on separate allotments, or if subsequent subdivision is proposed, the wall might also be considered an external wall and each dwelling may be required to have its own wall starting from the ground level (top of concrete footings or top of floor slab) and each achieving a 90/90/90 FRL if load bearing, or –/90/90 FRL if non-load bearing. Contact your local authorities, as there may also be applicable legislation or discretionary powers available to vary these provisions.

### Dwellings constructed side-by-side on a single allotment where subdivision may subsequently occur.

Where it is proposed to construct single dwellings side by side on a single allotment and it is known that subsequent subdivision will occur, or that subdivision might occur (and this will probably apply to most multi-dwelling developments) then, after subdivision, the internal fire separation wall might also be considered an external wall and each dwelling may be required to have its own wall starting from the ground level (top of concrete footings or top of floor slab) and be required to achieve a 90/90/90 FRL if load

bearing, or –/90/90 FRL if non-load bearing. Contact your local authorities, as there may also be applicable legislation or discretionary powers available to vary these provisions.

### PowerPanel<sup>XL</sup> Intertency solutions in tiered applications

Where the internal fire separation wall extends beyond the roof line on one side only and becomes an external wall, contact Hebel Engineering Services for advice on PowerPanel<sup>XL</sup> external wall solutions.

### Compliance with the Building Code of Australia (BCA)

All building solutions, such as walls, floors, ceilings, etc. must comply with the regulations outlined in the Building Code of Australia (BCA) or other authority.

The BCA is a performance based document, and is available in two volumes which align with two groups of 'Class of Building': Volume 1 – Class 2 to Class 9 Buildings; and Volume 2 – Class 1 & Class 10 Buildings – Housing Provisions. Each volume presents regulatory Performance Requirements for different Building Solutions for various classes of buildings and performance provisions.

These Performance Provisions include:

- Structure
- Fire Resistance
- Damp & Weatherproofing
- Sound Transmission & Insulation
- Energy Efficiency

This design guide presents tables and information necessary to design a PowerPanel<sup>XL</sup> Intertency Wall Systems installation that complies with the Performance Requirements of the BCA. The designer must check the adequacy of the building solution for Performance Requirements outlined by the appropriate authority.

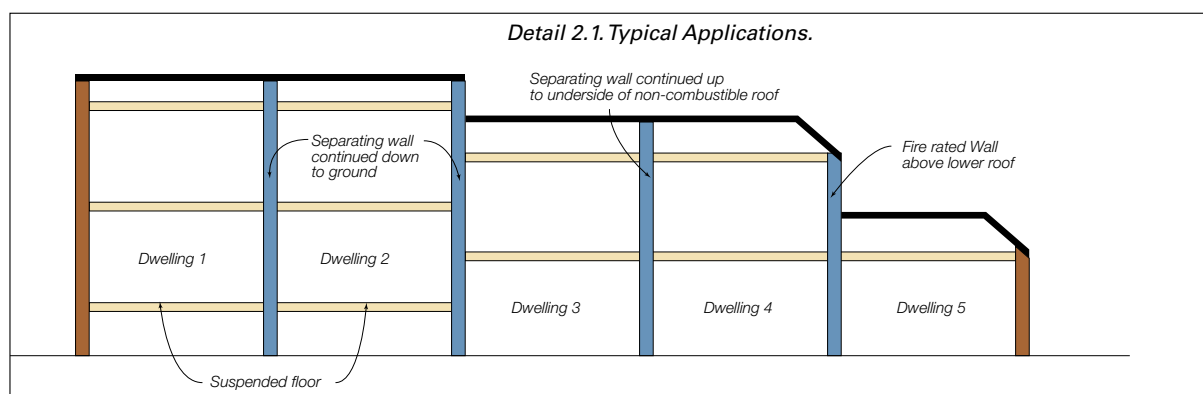

# 2.2 Sound Transmission & Insulation

## Overview

The Building Code of Australia (BCA) presents the Performance Requirements for sound insulation ratings. The sound insulation ratings set minimum values to consider two types of sound: airborne sound and impact generated sound.

The Performance Requirements for airborne sound insulation and impact sound insulation ratings are dependent upon the form of construction (i.e., walls or floors), Class of Building, and the type of areas being separated.

The airborne sound performance requirement is a value that could be the weighted sound reduction index ( $R_w$ ) or weighted reduction index with spectrum adaptation term ( $R_w + C_{tr}$ ). The impact sound performance requirement is a value called the weighted normalised impact sound pressure level with spectrum adaptation term ( $L_{n,w} + C_i$ ).

The BCA does provide Performance Requirements for the airborne sound and impact generated sound insulation ratings for a Intertenancy wall. Refer to Tables on page 7 and 8 for sound insulation resistance level of the PowerPanel<sup>XL</sup> Intertenancy Wall Systems.

## Impact Sound Performance

Impact sound is caused by vibrations, which are transferred directly through the wall and re-radiated as sound in the adjacent room. These sound vibrations can be generated by actions such as closing of a cupboard door.

The transfer of impact sound can be minimised by ensuring no mechanical connection exists between the two sides of the wall. For impact rated walls the BCA requires walls to be of 'discontinuous construction'. This refers to a wall maintaining a minimum 20mm cavity between two separate leaves except at the periphery.

*Note: For gap widths  $\leq 20\text{mm}$ , Hebel has obtained expert opinion that discontinuous construction performance will not be compromised*

## 2.2 Sound Transmission & Insulation (cont.)

### Acoustic Performance Design Recommendations

- 1) Hebel recommends engaging a specialist acoustic consultant on a project-by-project basis to provide design advice, confirmation of anticipated field performance, detailing and installation inspections.
- 2) When selecting the appropriate PowerPanel<sup>XL</sup> Intertenancy Wall System, the designer or specifier must be aware that the laboratory  $R_w$  values are almost always higher than the field measured values. Therefore, allowances should be made for the lower expected field values during the selection of the system.
- 3) Separate advice from a specialist acoustic consultant should be sought to determine the effect on acoustic performance due to any changes to the PowerPanel<sup>XL</sup> Intertenancy Wall System, and any required modification of the installation details pertaining to the systems.
- 4) Increasing of cavity widths, using higher density or thicker insulation or plasterboard, will generally maintain or increase the acoustic performance of the PowerPanel<sup>XL</sup> Intertenancy Wall Systems.
- 5) The acoustic performance values of the PowerPanel<sup>XL</sup> Intertenancy Wall Systems shown in Tables on page 7 and 8 are a guide only as to consistently achievable field performance. They do not constitute a field performance guarantee as factors such as the presence of flanking paths, quality of installation of the system, on-site detailing of junctions, room shapes and size, etc can significantly affect field performance. Maximising the field performance depends on the following factors:
  - The systems are installed in accordance with the manufacturer's standard installation details.
  - Good quality installation practices including the sealing of all junctions and joints and maintaining specified clearances.
  - The systems are installed with all junctions acoustically sealed so that negligible sound transmission occurs at these points.
  - Flanking paths are eliminated and the structures into which the systems are installed are capable of allowing the nominated rating to be achieved.
  - Site testing conditions.
  - To minimise the transfer of sound through the PowerPanel<sup>XL</sup> Intertenancy Wall Systems into the adjacent unit, it is suggested that a control joint be provided to break the mechanical path for the transmission of impact sound and other vibration.

# 2.3 Fire Resistance Performance

## Fire Resistance Level (FRL) Rating of Intertency Systems

The fire resistance level (FRL) rating performance of the PowerPanel<sup>XL</sup> Intertency Wall Systems detailed in this guide have been derived from Exova Warringtonfire assessment WFRA - 45771.10, WFRA - 45772.10.

This design guide has no recommendations for penetrations through the Intertency system. Hebel recommends contacting the appropriate consultant for design and detailing advice.

## System Variations

Certain variations to the PowerPanel<sup>XL</sup> Intertency Wall Systems installation will not affect the fire-resistance levels listed in Tables on page 7 and 8. However these variations need to be approved by the project fire consultant or project certifier. The possible variations to the systems include:

- 1) Changing the type of insulation between polyester, glasswool and rockwool;
- 2) Putting the insulation on both sides of the PowerPanel<sup>XL</sup> panel.



# 3.1 Installation Guidelines

## General

Before commencing any installation work, clean and tidy up the work area. Mark out the location of the walls.

## Wall Framing

Ensure frames are installed plumb and mechanically fixed to the substrate. All timber framework is to be fabricated and installed to the manufacturer's specifications and AS1684 or AS1720.1.

## Services

Ensure all services are installed within the wall frame and not on the face of the PowerPanel<sup>XL</sup> panel.

## Deflection Head Track

When the wall locations have been set out, fix the deflection head tracks to the substrate. This is done using suitable fixings (see Section 1.4) at 600mm maximum centres and maximum 100mm from ends. At changes in wall directions, ensure deflection head track is mitred with no gaps at the corners. Seal all butt joints with fire and acoustic sealant.

## Hebel Mortar

Mortar is placed on the DPC and should only be run out roughly 3 panels (1800mm) ahead of panel installation. The mortar bed fills the gap at the base. Generally, the mortar is 10mm thick and shall extend the full width of the panel. Mixing of the mortar should be done in accordance with the instructions on the bag.

## Wall Brackets

Screw fix the wall bracket to the top and bottom plates of the wall frame and to the PowerPanel<sup>XL</sup> panels at 600 centres in the discontinuous wall system. Locate within 50mm of the centre width of each panel using fixings specified in Section 1.4.

## Top Hats

Top Hats should be cut to size before securing them to timber studs in the non-discontinuous wall system. At control joints the Top Hats should be discontinuous. For number, location, spacing and fixing of Top Hats, refer to the project specifications. The project classification (Torrens or Strata) will determine the future external loading parameters of the panels and associated Top Hat and fixing arrangement required.

## Hebel PowerPanel<sup>XL</sup> panel

The Hebel PowerPanel<sup>XL</sup> panel in the intertenancy discontinuous and non-discontinuous wall systems must be installed vertically. The panels can be cut on-site using a circular saw equipped with diamond tipped cutting blade (for panel cutting limitations refer to Section 1.2). All the loose AAC particles should be brushed off the panel with a rough broom. Steel reinforcement that is exposed during cutting must be coated with a liberal application of corrosion protection coating (see Section 1.4). Any minor

damage and chips to the panels must be repaired using Hebel Patch. Use packers at the base to maintain the gap and ensure gap is full of mortar (if specified). The preferred method of fixing should be to screw through the Top Hat/ bracket into the panel. Fix the panel to the deflection head (if specified). For following panels, apply Hebel Adhesive to the vertical edge and install the next panel. Repeat the installation process until the wall is complete.

## Hebel Adhesive

Hebel Adhesive is applied to the panel with a 75mm Hebel notched trowel. When the panels are pushed together the joints are to be 2-3mm thick. Sufficient pressure must be applied to the panels when gluing to ensure the adhesive is fully bedded across the joint. Scrape off any excess adhesive protruding from the joints and fill any gaps. Adhesive is to be mixed to the proportions and consistency as per the instructions on the bag.

## Bradford Insulation

Installation of Bradford insulation should be completed in accordance with manufacturer's handling and installation guidelines. The insulation provided should completely fill the space between the stud framing and form a continuing barrier. If there is any gap in the insulation the acoustic performance of the system may be adversely affected.

## Gyprock<sup>™</sup> Plasterboard

Plasterboard sheets must be cut to fit neatly and should not be forced into position. The plasterboard is to extend the full height of the wall frame, with gaps at top and bottom for the specified sealant. Plasterboard is fixed directly to the stud framework in accordance with the Gyprock<sup>™</sup> Plasterboard Residential Installation Guide, GYP547.

## Sealants

All movement joints and other gaps should be sealed off and finished neatly with polyurethane fire and acoustic rated sealants. Installation of sealants must be carried out in accordance with the manufacturer's specifications.

## Installation of Electrical, Plumbing and Other Services

Installation of services into walls should be carried out at an appropriate construction sequence. This will allow easy access to cavities and wall frames, where services can be easily installed and neatly hidden.

Hebel suggests installing the plumbing and cabling after the panels have been installed. The builder or project manager should confirm appropriate construction sequence for services on a project-by-project basis.

## Fasteners & Fixings

All fixings and fasteners should be installed in accordance with the manufacturer's specifications.

# 3.2 Construction for PowerPanel<sup>XL</sup> Intertency Discontinuous Wall Systems

## 16.1 Overview of PowerPanel<sup>XL</sup> Intertency Discontinuous Wall Systems

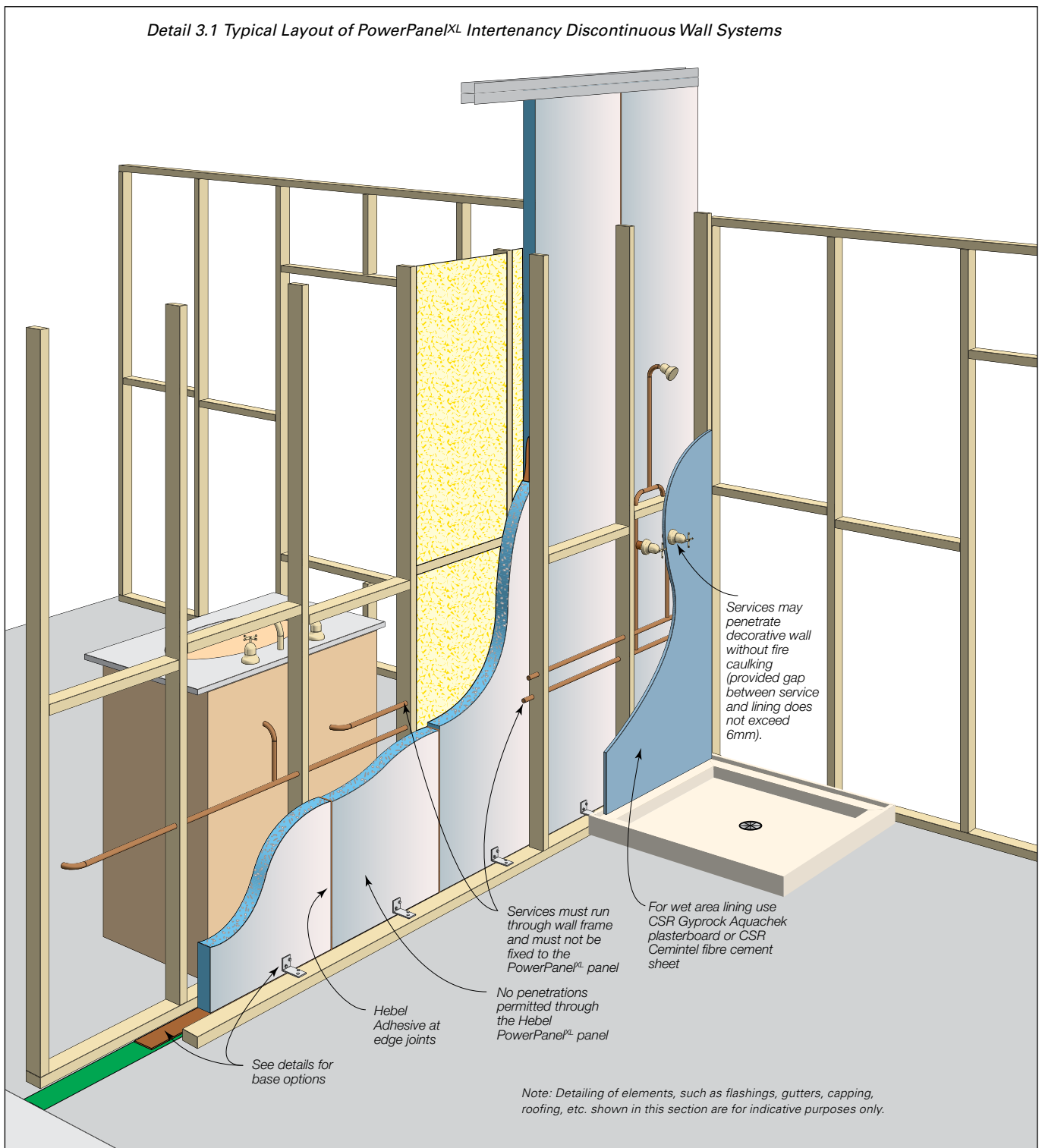

Detail 3.2 Vertical Cross Section of PowerPanel<sup>XL</sup> Intertency Discontinuous Wall Systems

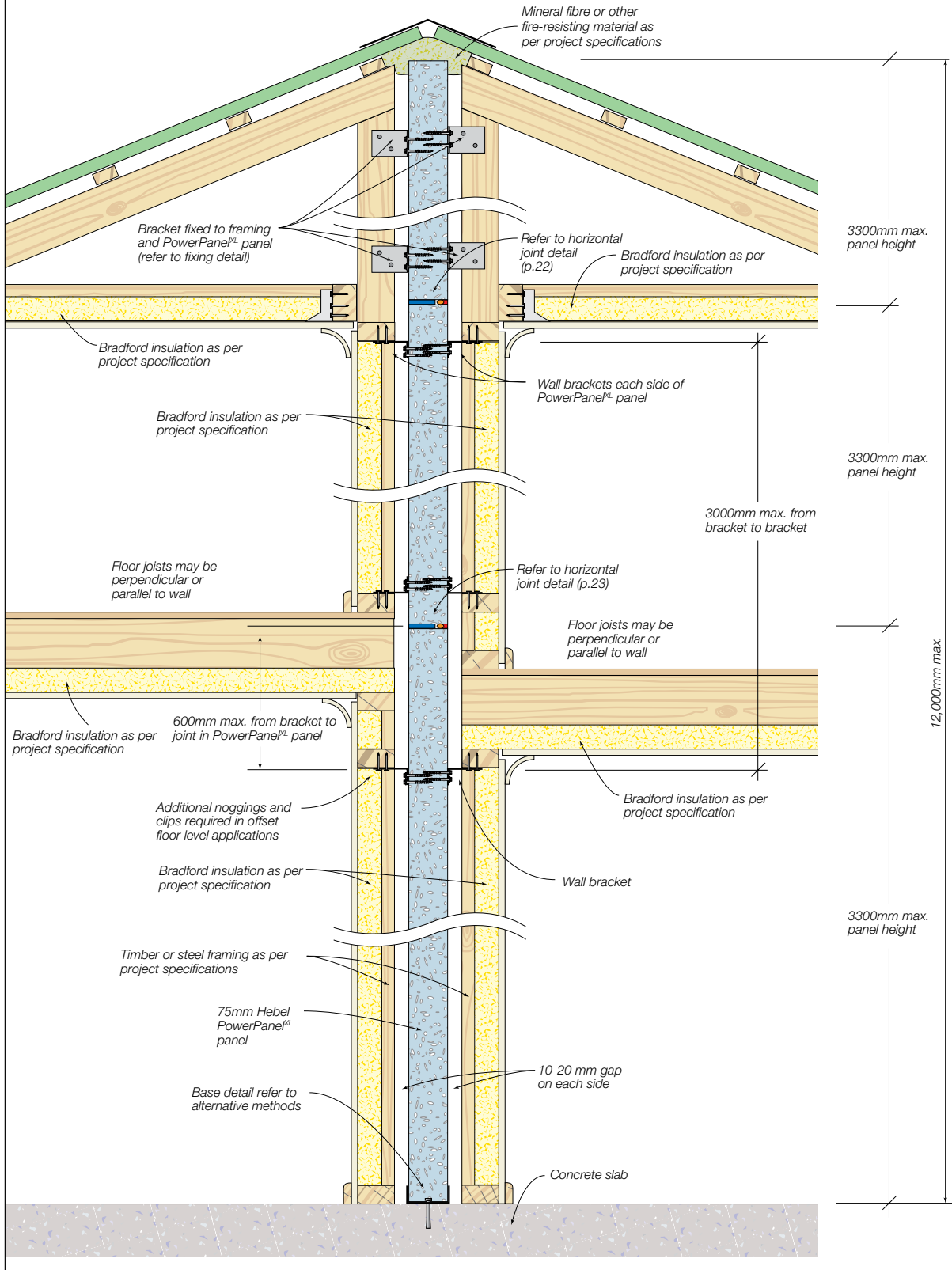

# 3.3 Construction for Intertenancy Discontinuous

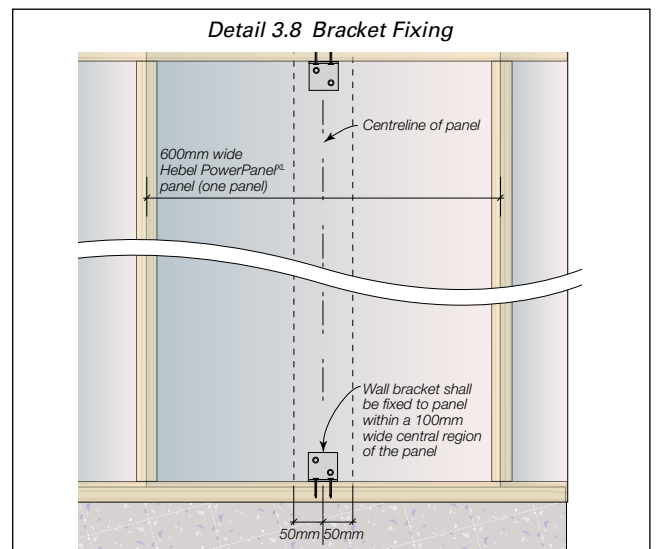
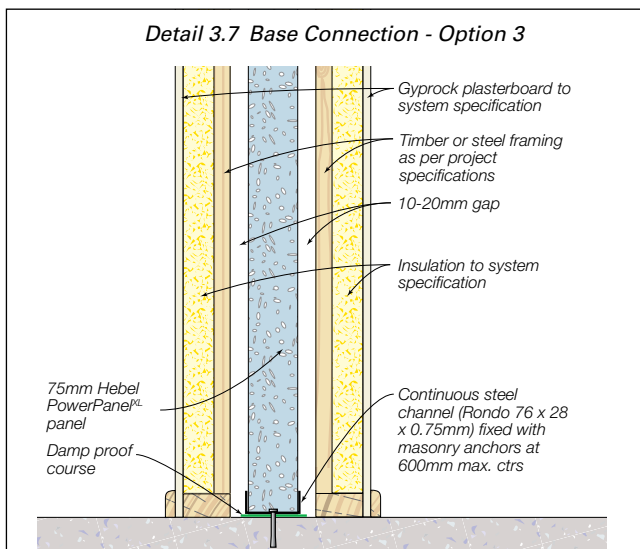
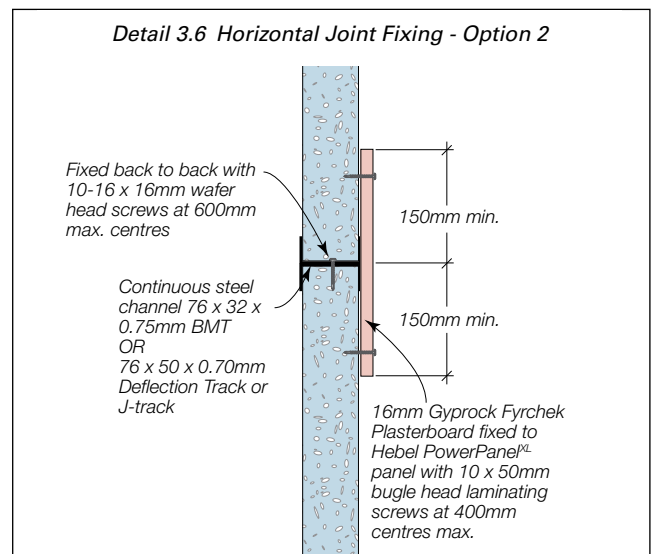
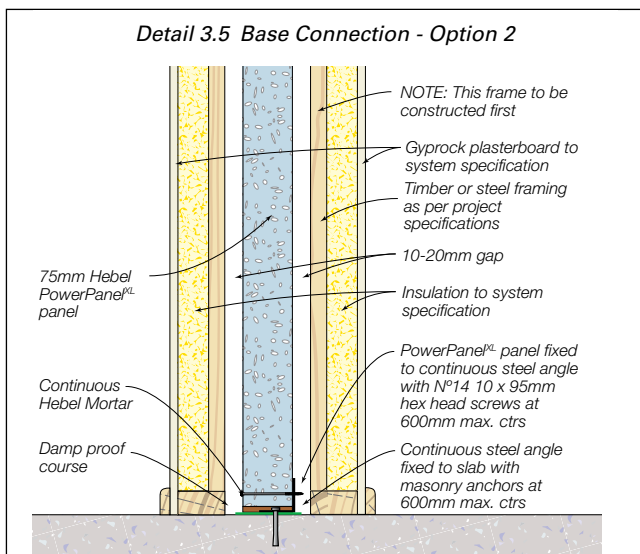
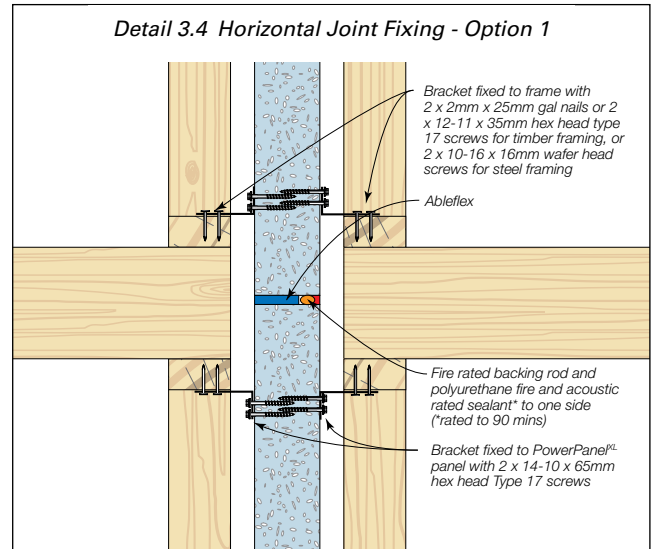
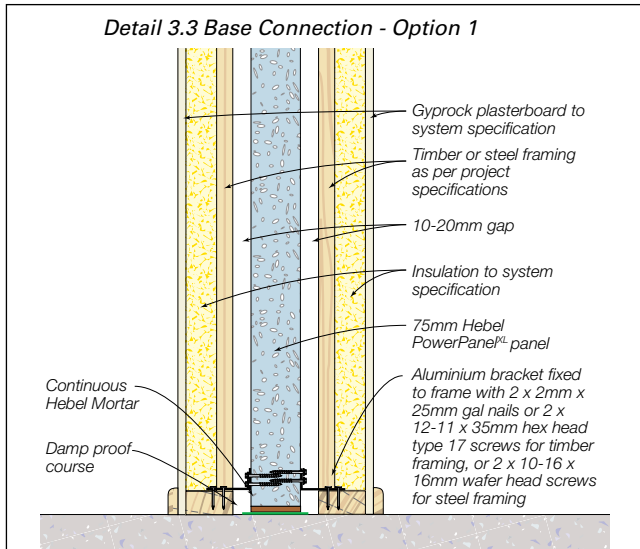

Detail 3.9 Roof Valley for PowerPanel<sup>XL</sup> Intertency Discontinuous Wall Systems

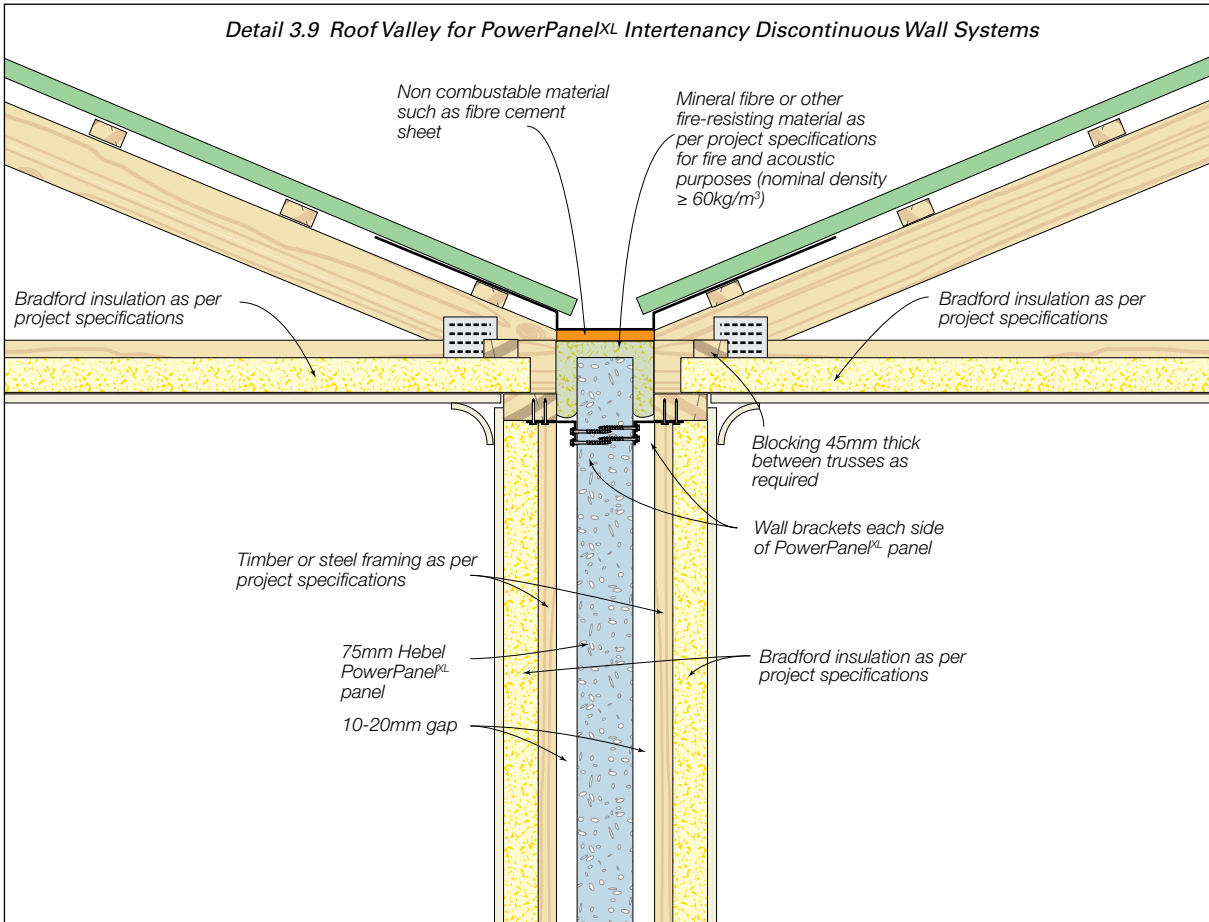

Detail 3.10 Roof Parapet for PowerPanel<sup>XL</sup> Intertency Discontinuous Wall Systems

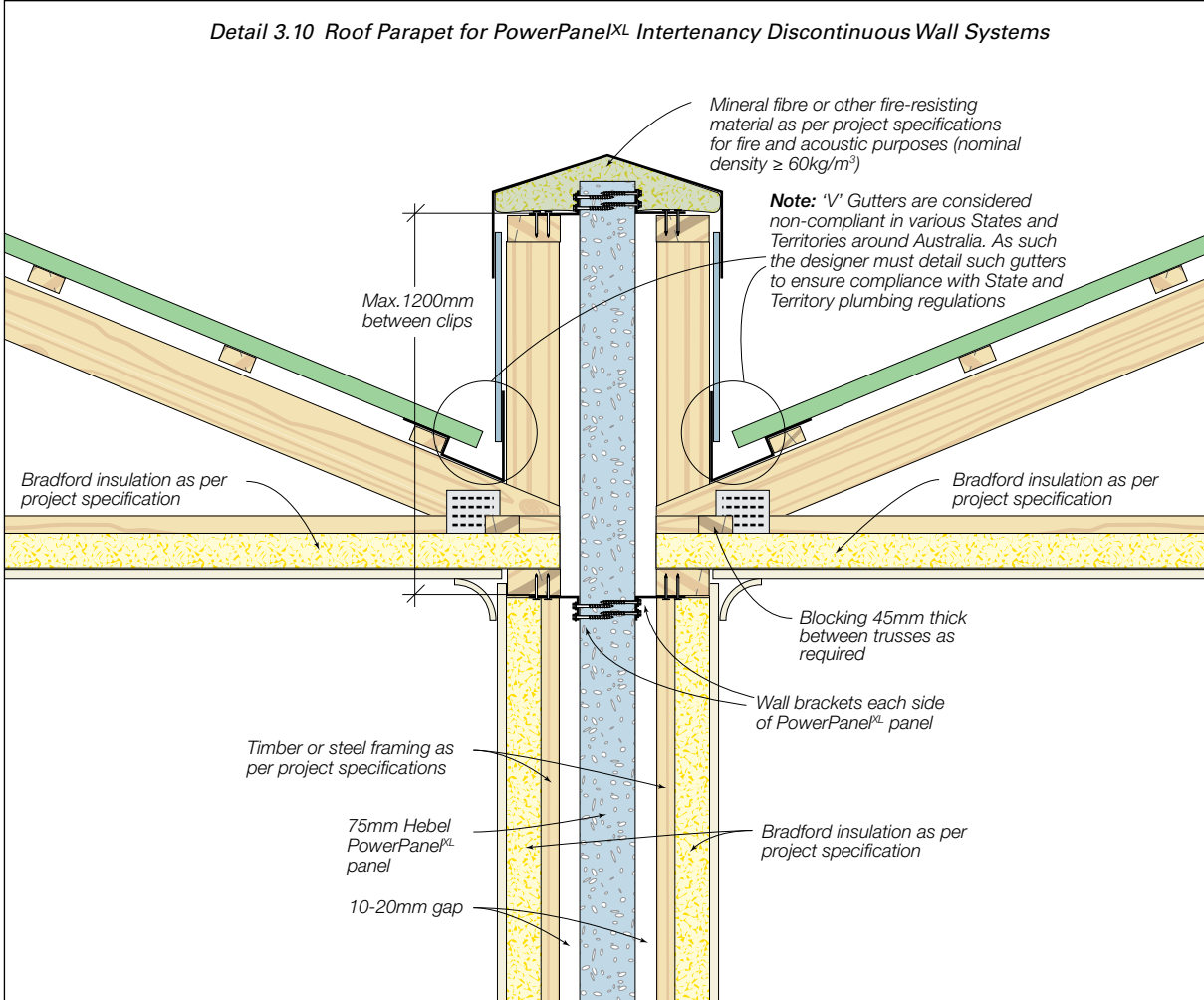

# 3.4 Junction Details for Intertency Discontinuous

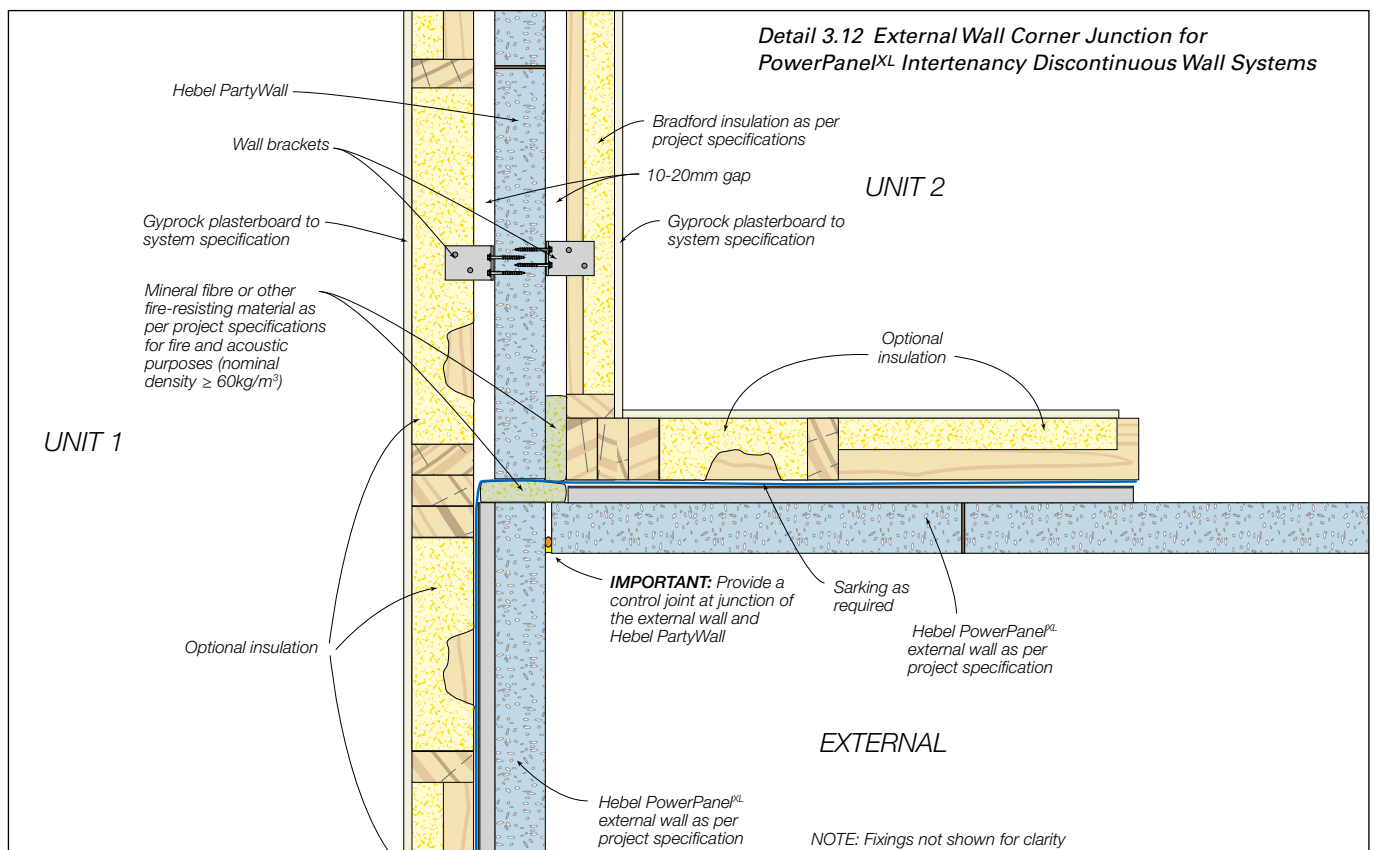
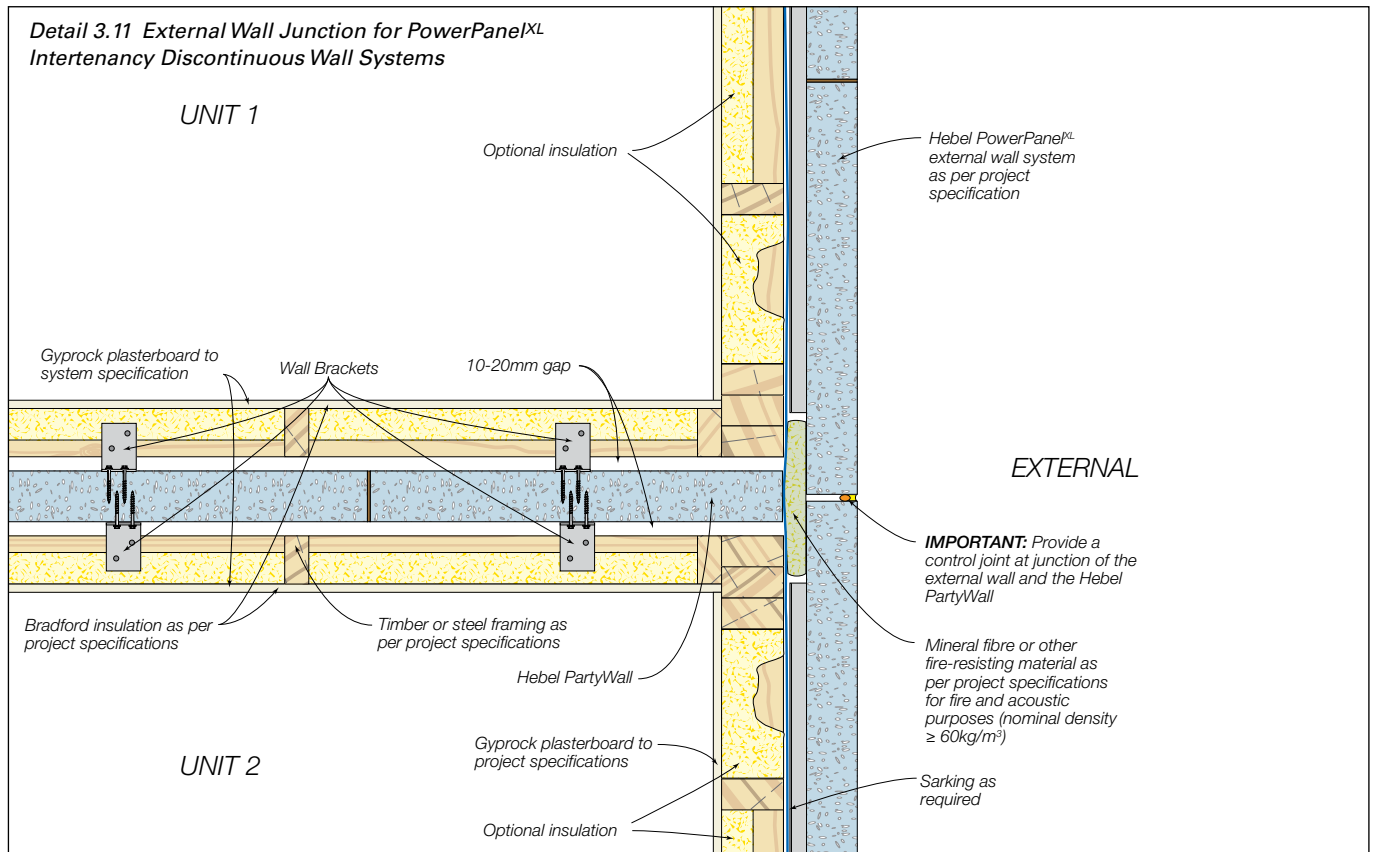

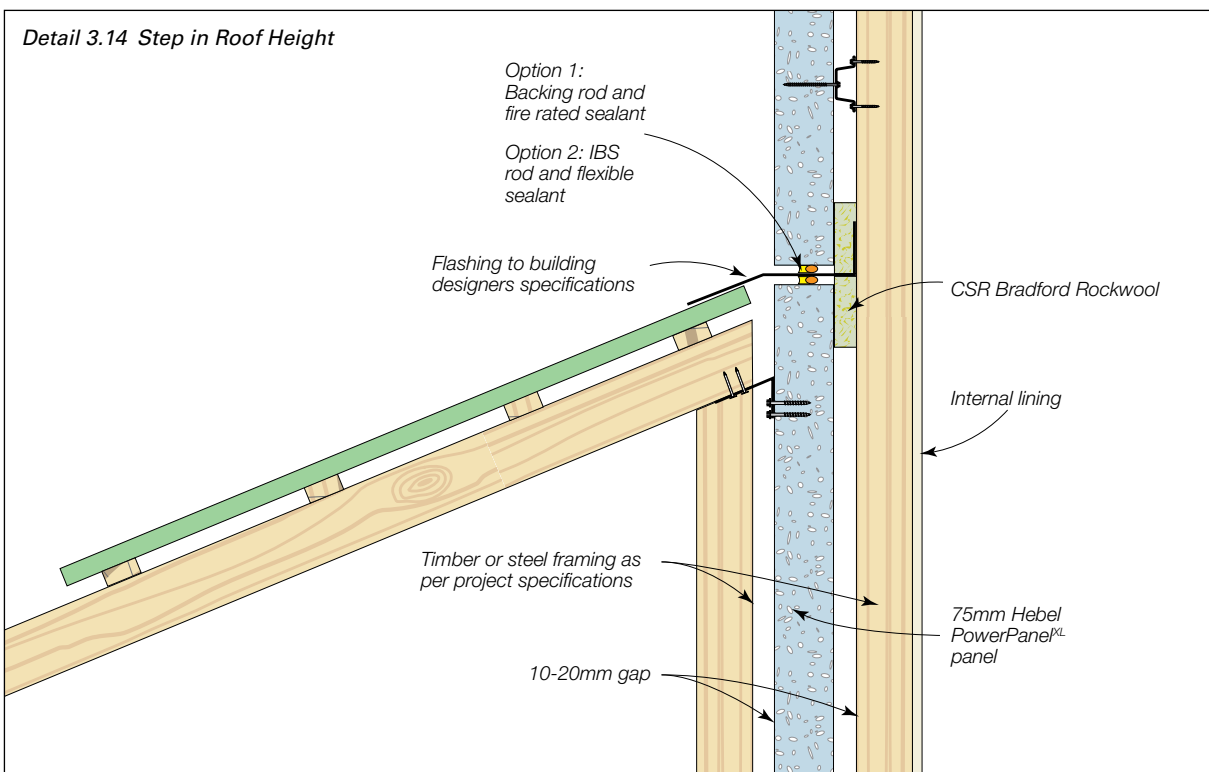
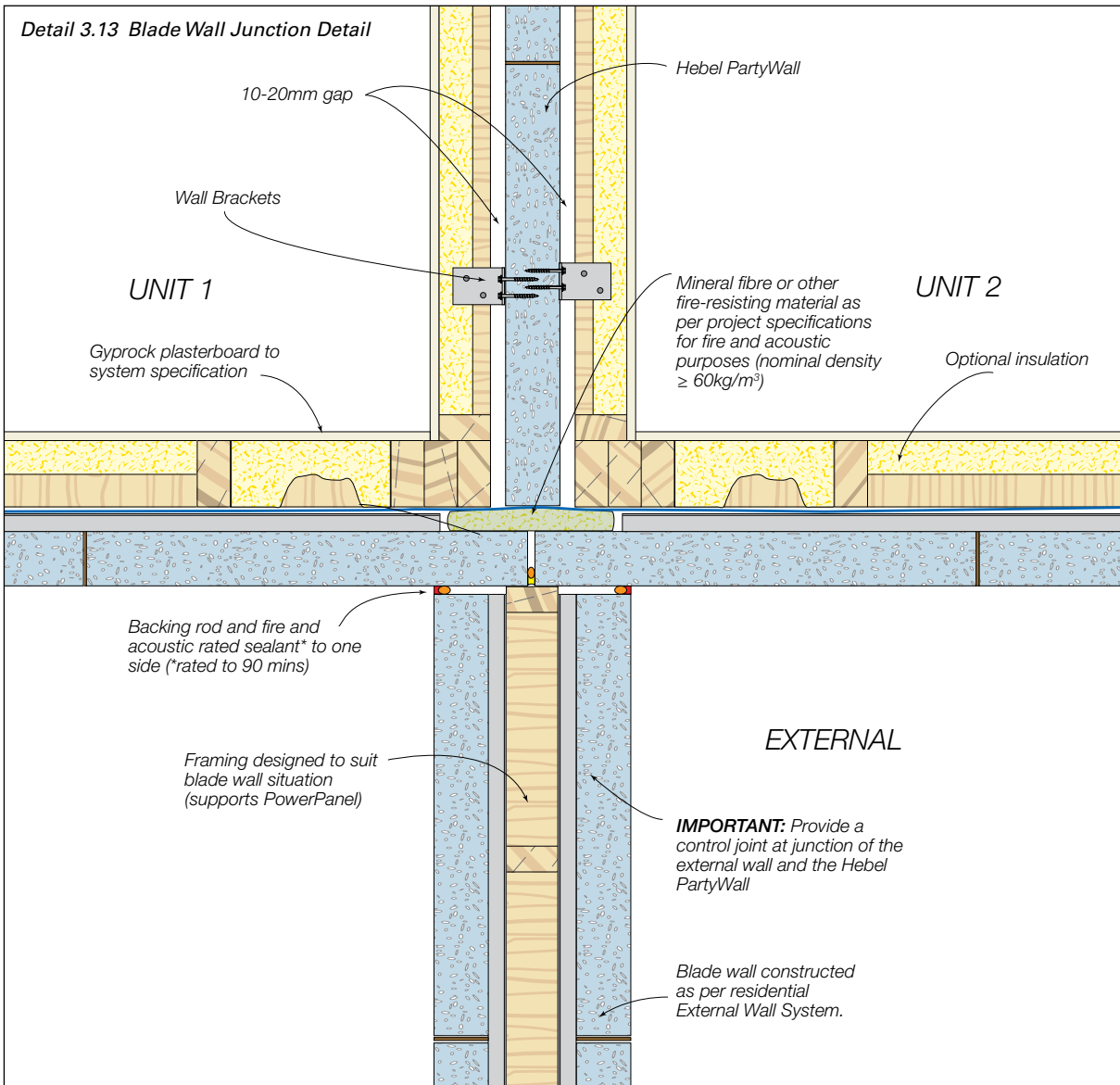

# 3.5 Construction for PowerPanel<sup>XL</sup> Intertency Non-discontinuous Wall Systems

## Overview of PowerPanel<sup>XL</sup> Intertency Non-discontinuous Wall Systems

*\*Not suitable for steel frame construction. Not deemed discontinuous construction.*

*Detail 3.15 Typical Layout of PowerPanel<sup>XL</sup> Intertency Non-discontinuous Walls Systems*

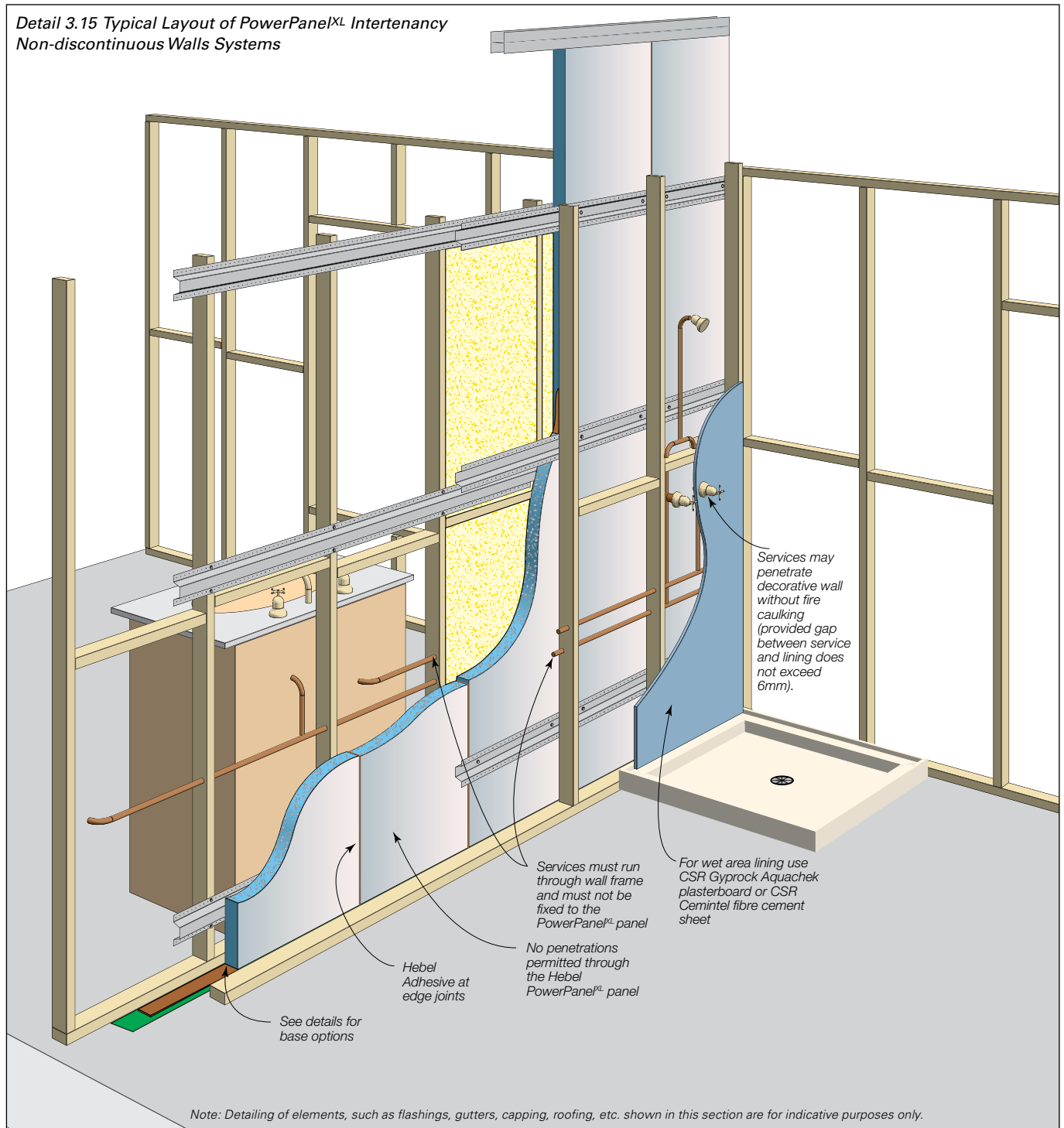



**Detail 3.16 Vertical Cross Section of PowerPanel<sup>XL</sup> Intertency Non-discontinuous Wall Systems**

*\*Not suitable for steel frame construction. Not deemed discontinuous construction*

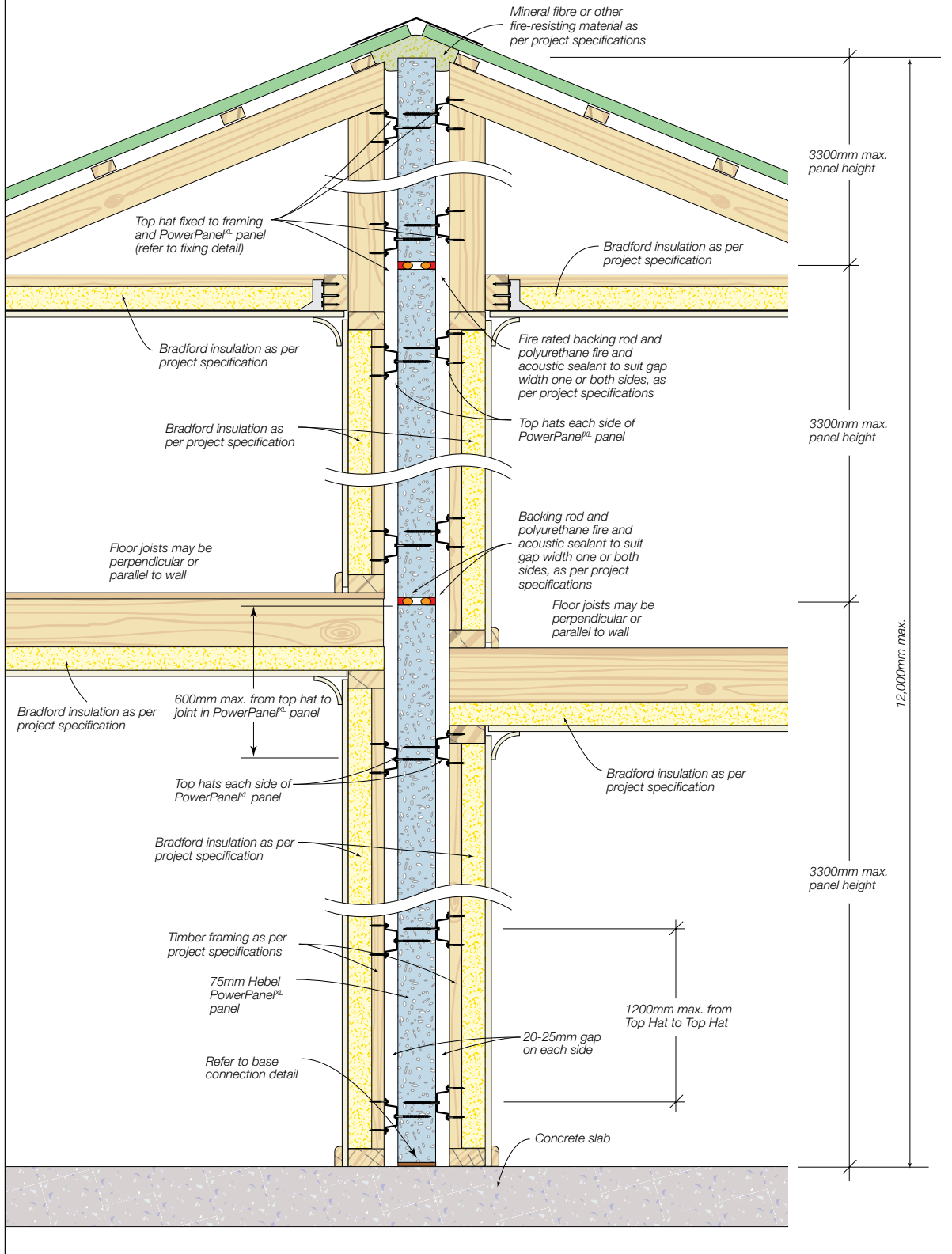

# 3.6 Construction for PowerPanel<sup>XL</sup> Intertency Non-discontinuous Wall Systems

*\*Not suitable for steel frame construction. Not deemed discontinuous construction*

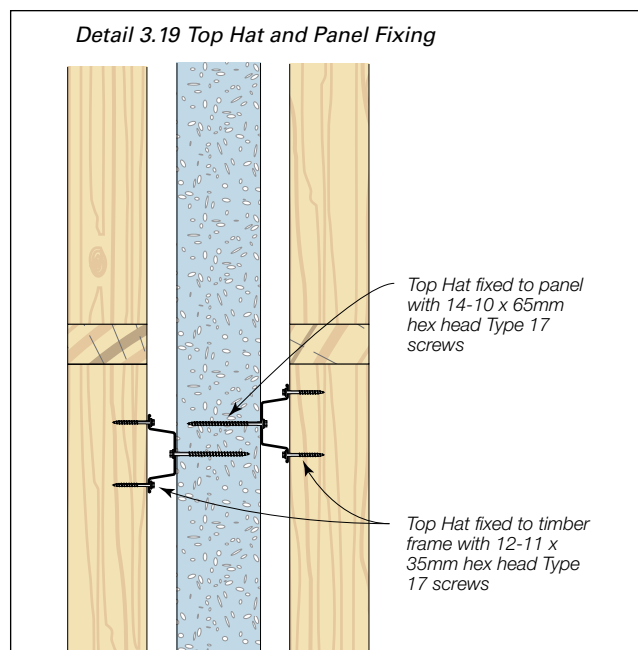
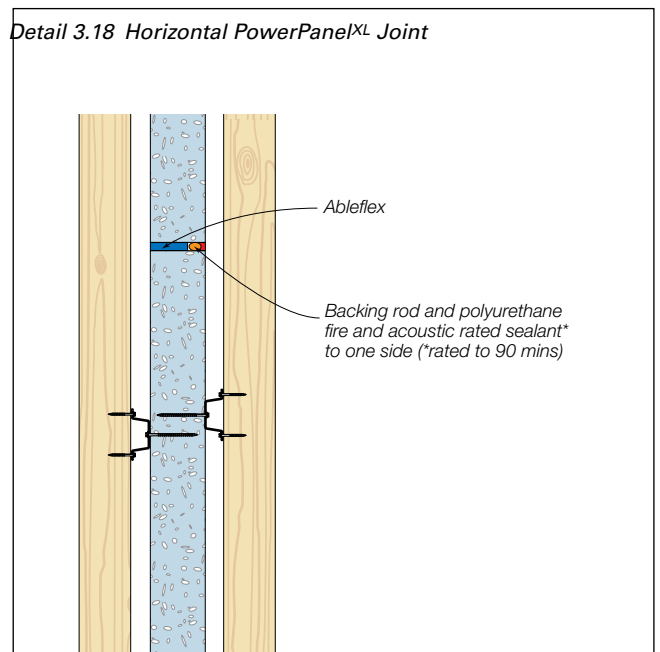
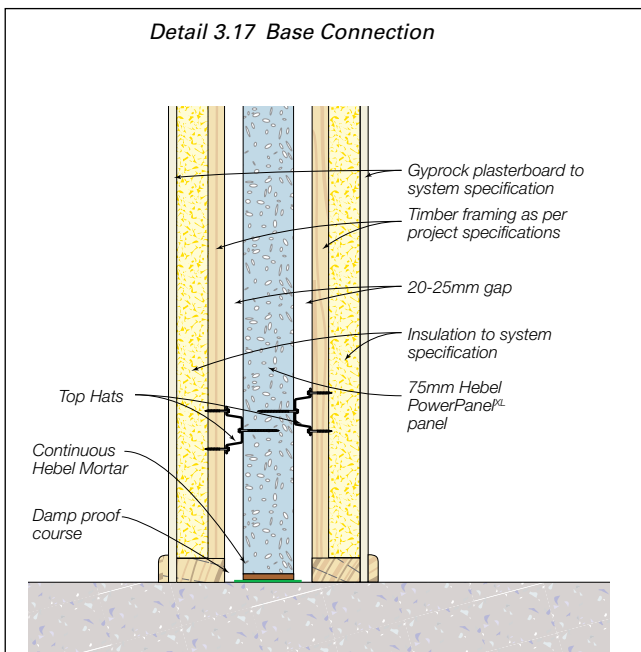

**Detail 3.20 Roof Valley for PowerPanel<sup>XL</sup> Intertency Non-discontinuous Wall Systems**

*\*Not suitable for steel frame construction. Not deemed discontinuous construction*

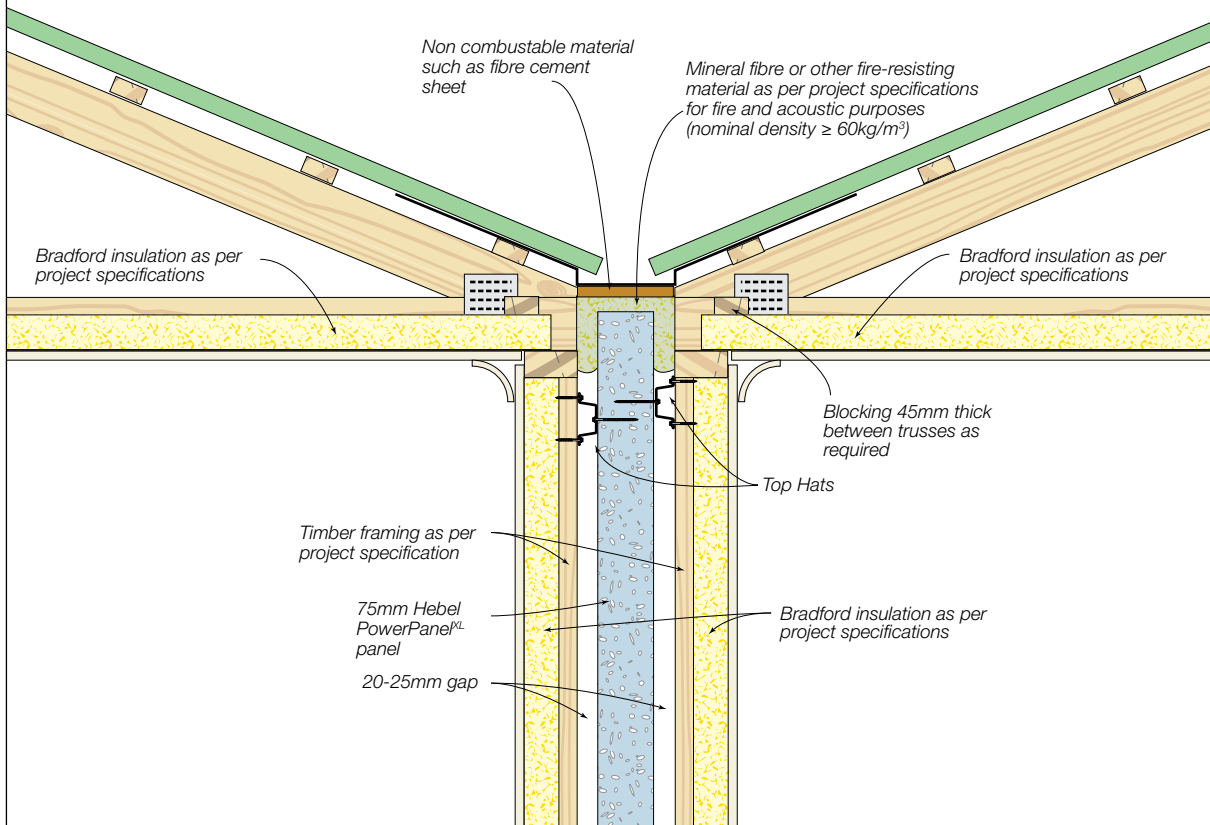

**Detail 3.21 Roof Parapet for PowerPanel<sup>XL</sup> Intertency Non-discontinuous Wall Systems**

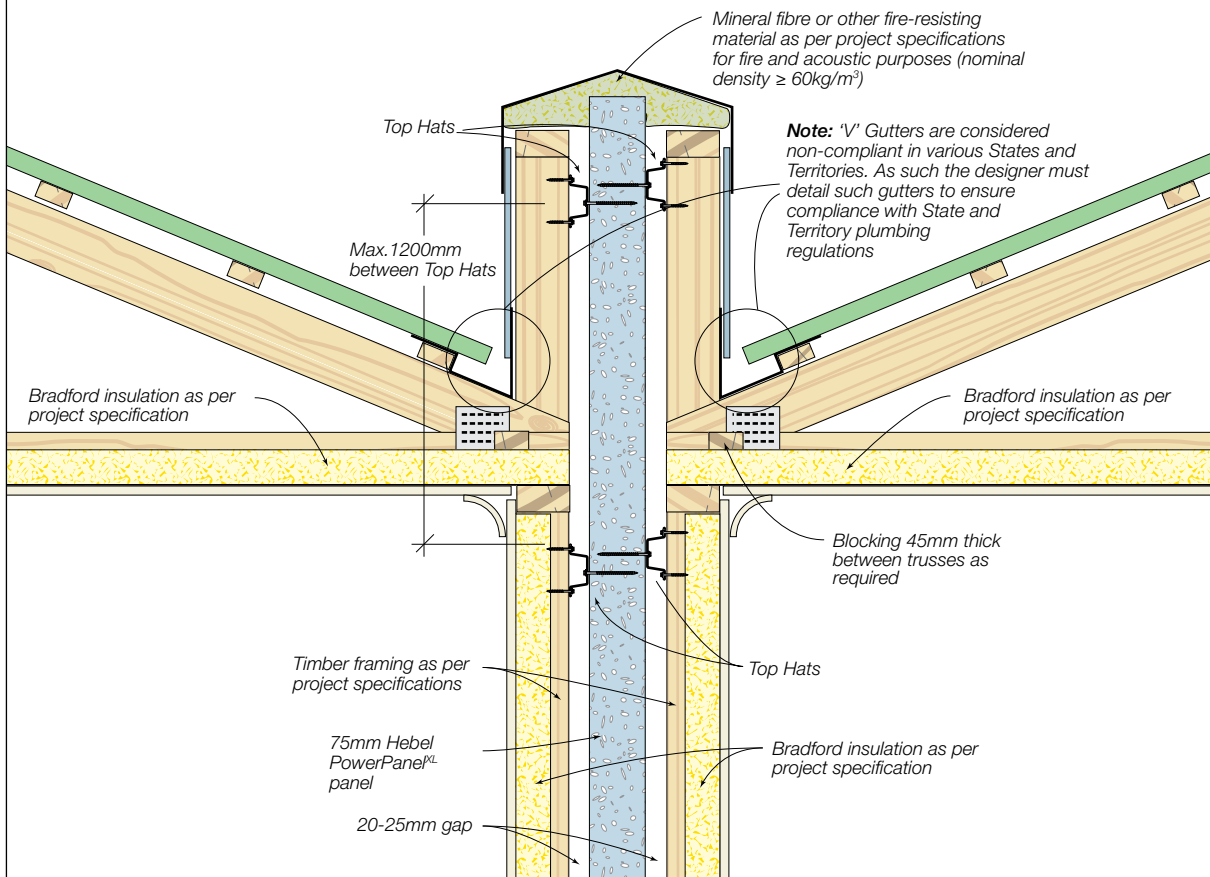

# 3.7 Junction Details for Intertenancy Non-discontinuous

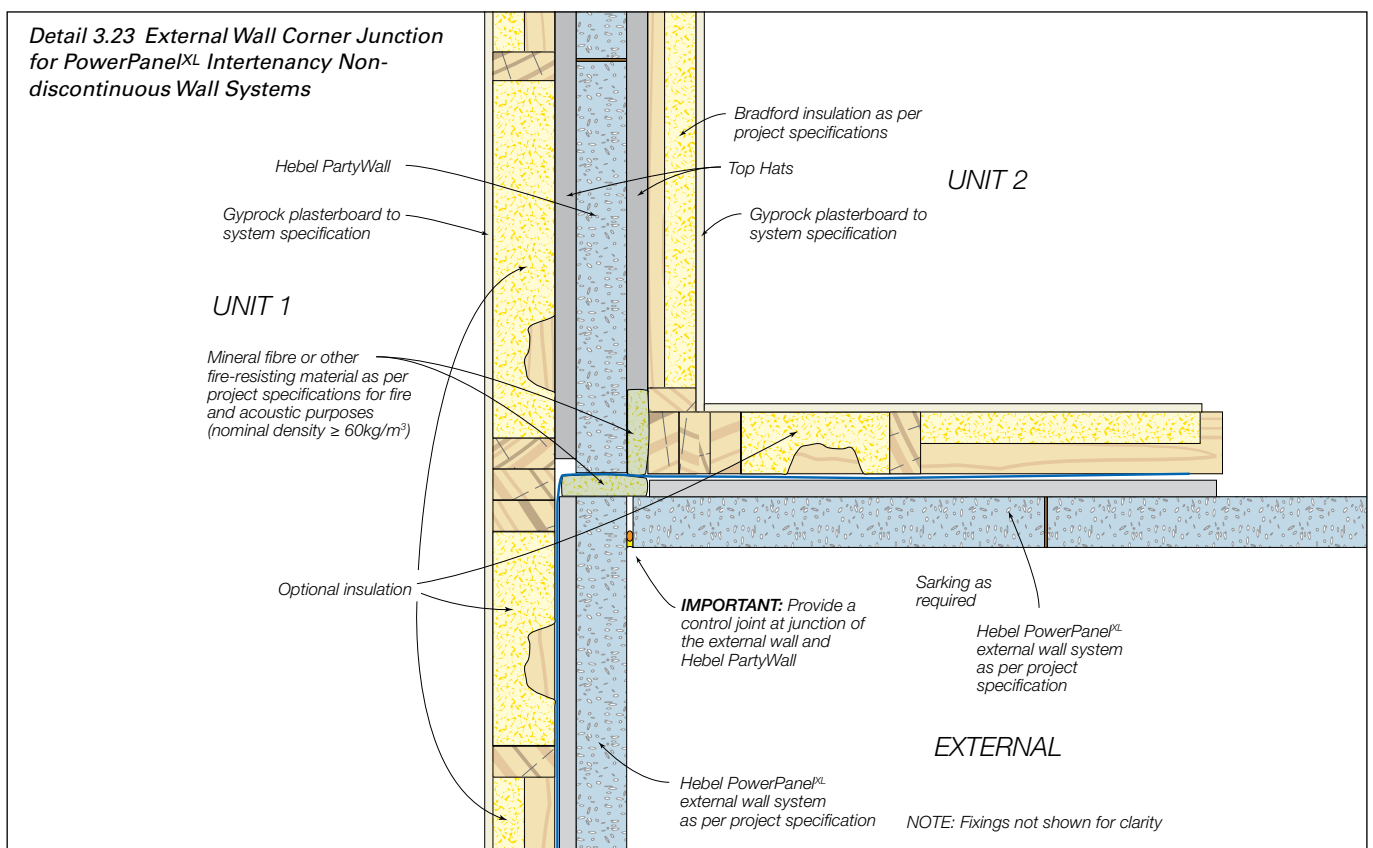
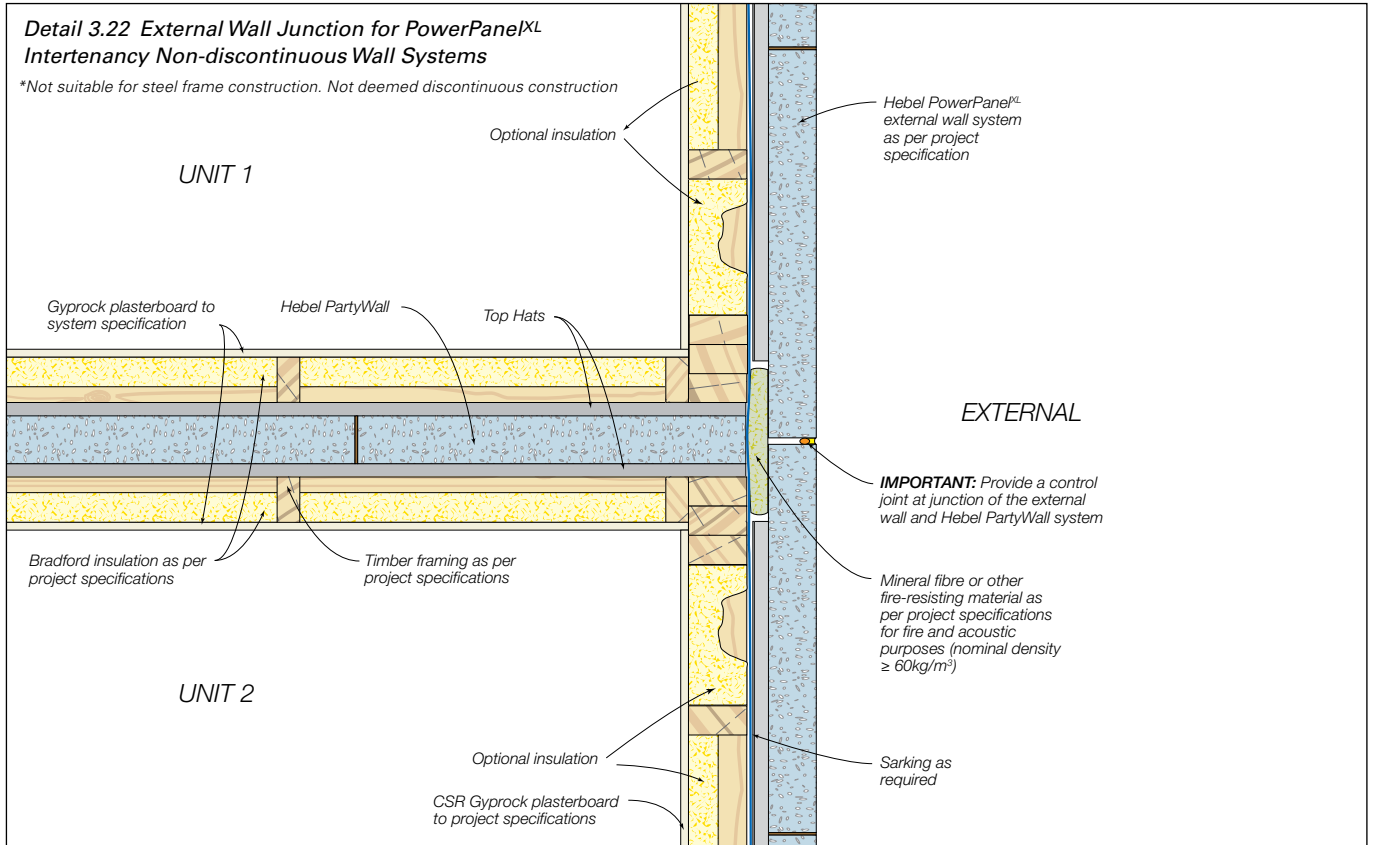

# 4.1 Delivery and storage

## Unloading Panel Packs

Panel packs shall be unloaded and moved with only approved lifting devices. Before use, the lifting devices should be checked for the required lifting tags. Packs should be unloaded as close as possible to the intended installation area. This will increase work efficiency and minimise the need for secondary lifting.

*NOTE: Secondary handling increases the risk of panel damage. The repair of damage sustained during lifting and moving is the responsibility of the lifter. Where such damage is excessive, PowerPanel<sup>XL</sup> panels must be replaced.*

## Storage

All materials must be kept dry and preferably stored undercover. Care should be taken to avoid sagging or damage to ends, edges and surfaces.

All Hebel products must be stacked on edge and properly supported off the ground, on a level platform. Panel bundles can be stacked two high. The project engineer should be consulted as to the adequacy of the structure to support the stacked bundles.

If outside, Hebel panels must be stored off the ground and protected from the weather. Only single bundles positioned on the ground can be opened. To provide a level surface, we recommend placing temporary joists beneath the supporting cleats.

## Unstrapping Packs

Ensure appropriate bracing is installed to packs prior to removal of strapping to prevent panels from falling. Panels can be held together with sash clamps, ratchet, straps or Hebel stabilising bars.

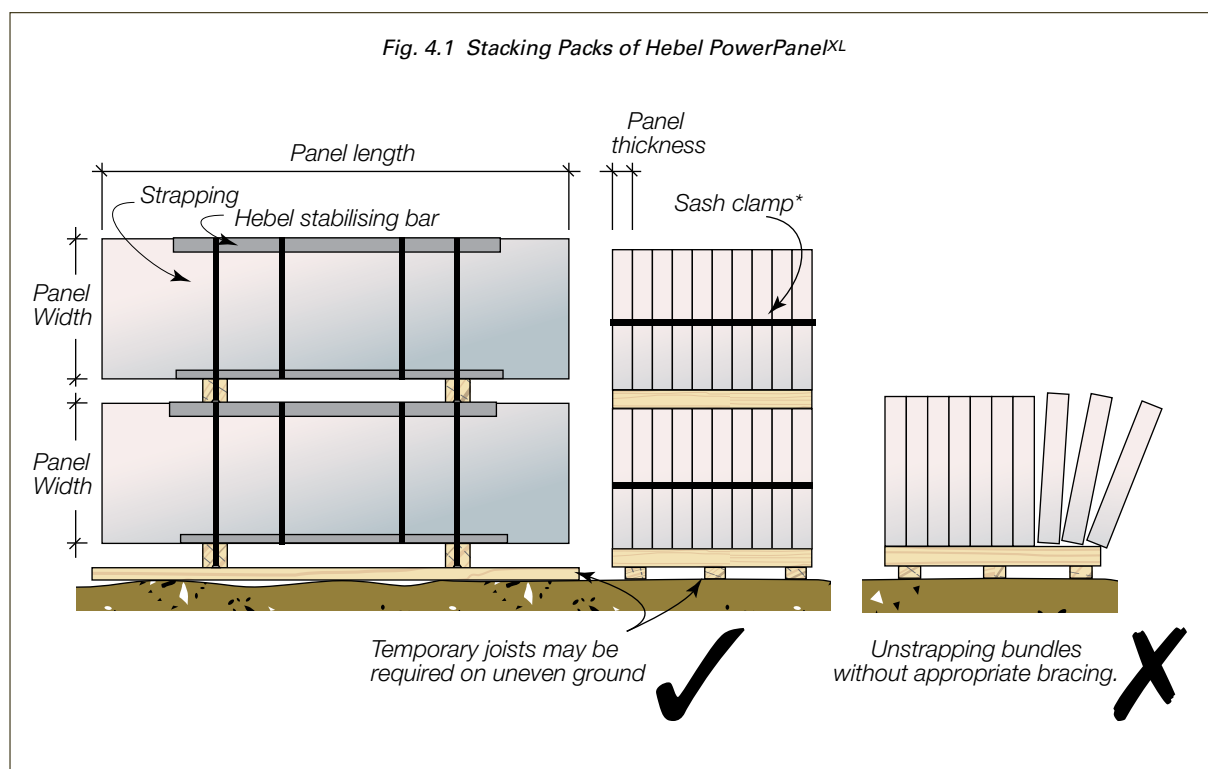

## 4.2 Hebel Hoist

Hebel has developed an innovative hoisting solution that now makes it easy to install boundary walls and vastly improves the efficiency of installing intertenancy walls in areas with limited access.

This revolutionary lifting device attaches directly to the frame and features a rail and hoist which allows panels to be safely lifted, transported and placed precisely from above before being fixed from the inside of the building.

Suitable for steel or timber frames up to three storeys high, the Hebel Hoist allows builders to streamline their workflow by erecting all the frames first before installing the external panels. It also has the potential to allow builders to increase the footprint of their buildings by moving external walls right up to the boundary.

The Hebel Hoist is only available through trained and accredited Hebel installers. Please contact your local Hebel sales representative or the Hebel customer service centre to discuss the opportunity to improve your efficiency and profitability using Hebel Hoist.

### **Mechanically Assisted Handling**

Moving and handling Hebel panels should be done as much as possible using mechanical aids such as forklifts, cranes and special panels lifting trolleys. Guidelines for handling Hebel PowerPanel<sup>XL</sup> using the PowerPanel<sup>XL</sup> Trolley or PowerPanel<sup>XL</sup> lifters are detailed in Technical Bulletin Hebel PowerPanel<sup>XL</sup> Handling & Installation Guidelines, NoHTB791.

### **Health, Safety & Personal Protective Equipment (PPE)**

Hebel products are cement-based, which may irritate the skin, resulting in itching and occasionally a red rash. The wearing of gloves and suitable clothing to reduce abrasion and irritation of the skin is recommended when handling Hebel products. Approved respirators (AS/NZS1715 and AS/NZ1716) and eye protection (AS1336) should be worn at all times when cutting and chasing. Refer to the Hebel Material Safety Data Sheets. Refer to the back of this Design & Installation Guide for further information regarding health and safety.



## 4.3 Panel handling

### Manual Handling

Hebel recommends using a trolley or other mechanical apparatus to move the panels around the work site. Manual handling where people physically move a panel, should be kept to a minimum, with the weight being supported by an individual kept as small as possible. Any concerns regarding the weight to be handled should be discussed with the panel installation contractor.

To minimise the possibility of manual handling injuries, Hebel suggests the following:

- Use mechanical aids, such as trolleys, forklifts, cranes and levers, or team lifting to move panels
- Keep the work place clean to reduce the risk of slips, trips and falls, which can cause injury
- Plan the sequence of installation to minimise panel movements and avoid awkward lifts
- Train employees in good lifting techniques to minimise the risk of injury

### Health, Safety & Personal Protective Equipment (PPE)

Hebel AAC products are cement-based, which may irritate the skin, resulting in itching and occasionally a red rash. The wearing of gloves and suitable clothing to reduce abrasion and irritation of the skin is recommended when handling Hebel AAC and other concrete products. Approved respirators (AS/NZS1715 and AS/NZ1716) and eye protection (AS1336) should be worn at all times when cutting and chasing. Refer

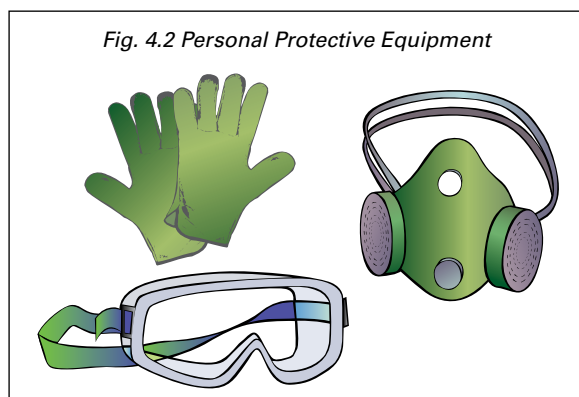

Fig. 4.2 Personal Protective Equipment

to the appropriate Hebel Material Safety Data Sheet (MSDS). For further information, contact Hebel or visit the website: [www.hebelaustralia.com.au](http://www.hebelaustralia.com.au)

### Cutting

The use of power tools when cutting concrete products may cause dust, which contains respirable crystalline silica, with the potential to cause bronchitis, silicosis and lung cancer after repeated and prolonged exposure. When using power or hand tools, on Hebel products, wear a P1 or P2 respirator and eye protection. When cutting, routing or chasing Hebel products with power tools, use dust extraction equipment and wear hearing protection. Refer to the appropriate Hebel MSDS. For further information, contact Hebel or visit the website:

[www.hebelaustralia.com.au](http://www.hebelaustralia.com.au)

Reinforcement exposed during cutting is to be coated with a liberal application of Hebel Anti-Corrosion Protection Paint.

### Trolley Assisted Handling

Hebel has developed a trolley to allow easier and safer handling of Hebel PowerPanel<sup>XL</sup> on-site (refer Image 4.3). There is a range of trolleys to suit panels from 1.2m to 3.9m in length.

Guidelines for handling Hebel PowerPanel<sup>XL</sup> using the Hebel PowerPanel<sup>XL</sup> Trolley or panel lifters are detailed in Technical Bulletin, Hebel PowerPanel<sup>XL</sup> Handling & Installation Guidelines.

Fig 4.3 Hebel PowerPanel<sup>XL</sup> Trolley



# 4.4 Design, Detailing and Performance Responsibilities

Hebel engages independent acoustic testing laboratories to test and report on the performance of a wall in accordance with the relevant Australian Standards. Consultants use these reports as the basis for opinions (estimates of laboratory performance) they issue for variations or different arrangements to the tested system, and also to design and specify walls that meet appropriate criteria for a particular project. Using their experience, consultants will make judgements about on-site installed performance of various walls. The performance levels of walls documented in this Design Guide are either what is reported in a test or the documented opinion of an consultant.

Performance in projects is typically the responsibility of;

## Project Consultants (Acoustic, Fire, Structural, etc.):

- Opinions on expected laboratory performance of wall configurations that vary from actual test configuration, such as substitution products and components.
- Judgements about expected field performance using laboratory test reports and practical experience.
- Design, specification and certification of acoustic, fire, structural and any other required performance for individual projects. This involves the design and selection of building elements, such as walls and floors and their integration in the building considering the following:
  - Interface of different building elements and to the structure/substrate
  - Wall and floor junctions
  - Penetrations
  - Flanking issues
  - Room/building geometry
  - Acoustic field testing

## Project Certifier &/or Builder:

- Identifying the performance requirements for the project in accordance with the Building Code of Australia and clearly communicating this to relevant parties.
- Applicability of any performance requirements supplied by Hebel including tests and opinions for the project.
- The project consultant's responsibilities detailed above if one is not engaged in the project.

Hebel does not provide consulting services. Hebel only provides information that has been prepared by others and therefore shall not be considered experts in the field. Any Intertency using the information contained in this design guide or supplied by Hebel in the course of a project must satisfy themselves that it is true, accurate and appropriate for the application, consequently accepting responsibility for its use.

It is the responsibility of the architectural designer and engineering parties to ensure that the details in this design guide are appropriate for the intended application. The recommendations of this guide are formulated along the lines of good building practice, but are not intended to be an exhaustive statement of all relevant data. Hebel accepts no responsibility for, or in connection with, the quality of the recommendations or their suitability for any purpose when installed. CSR Building Products Limited is not responsible for the performance of constructed walls, including field performance, and does not interpret or make judgements about performance requirements in the Building Code of Australia.



# Appendix A

## A1 – Hebel PowerPanel<sup>XL</sup> Material Properties

### Manufacturing Tolerances

Length	±5mm
Width	±1.5mm
Thickness	±1.5mm
Diagonals (max.)	5mm
Edge straightness deviation (max.)	1.5mm

### Hebel PowerPanel<sup>XL</sup> Physical Properties

- 1) Hebel PowerPanel<sup>XL</sup> profile and nominal dimensions are shown in Table 1.6.
- 2) Panel reinforcement is a single layer of steel mesh with 4 longitudinal wires of 4mm diameter.
- 3) Nominal dry density of AAC = 400 kg/m<sup>3</sup>.
- 4) Average working density of AAC = 580 kg/m<sup>3</sup> at 45% moisture content.
- 5) Average service life density of AAC = 440 kg/m<sup>3</sup> at 10% moisture content.

### PowerPanel<sup>XL</sup> Strength Properties

- 1) Characteristic Compressive Strength of AAC,  $f'_{cm} = 2.38$  MPa.
- 2) Average Compressive Strength of AAC = 2.8 MPa.
- 3) Characteristic Modulus of Rupture,  $f'_{ut} = 0.40$  MPa

### PowerPanel<sup>XL</sup> Acoustic Properties

- 1) Panel only with no plasterboard or other lining  $R_w = 34$  dB,  $R_w + C_{tr} = 30$  dB (refer to Acoustic Logic Test Report Ref: 2010861.15/2602A/R2/GW).

### PowerPanel<sup>XL</sup> Thermal Properties

- 1) R-Value of PowerPanel<sup>XL</sup> with no plasterboard or other lining = 0.52 m<sup>2</sup>.K/W (8.15% moisture content).

### Fire Hazard Indices

Hebel AAC products have the following early fire hazard indices, determined in accordance with AS1530.3:1990:

Ignitability Index:	0
Spread of Flame Index	0
Heat Developed Index	0
Smoke Developed Index	0-1

### Fire Resistance Level (FRL)

For fire performance characteristics of PowerPanel<sup>XL</sup> low rise Intertency Wall Systems, refer to Section 2.3 and pages 7 and 8 of this publication.

## A2 Assessment Methods

### Test Reports

Assessment reports on PowerPanel<sup>XL</sup> Intertency Discontinuous and Non-discontinuous Wall Systems have been prepared in accordance with relevant Australian Standards.

Fire assessments have been issued by Exova Warringtonfire Research (Aust) Pty Ltd.

Assessments and opinions quoted in this design guide are available on request from Hebel.

### Sound Insulation Estimates

Acoustic consultants often use computer models to determine sound transmission estimates for specific wall system configurations. These are known as 'Acoustic Assessments' or 'Acoustic Opinions'. The computer model predicts the  $R_w$  performance expected from a laboratory test on the system. Acoustic opinions have been issued by PKA Acoustic Consulting Pty Ltd. All acoustic opinions quoted in this design guide are available on request from Hebel.

# Appendix B

## B1 Architectural Specification

This specification should be adopted as a guide only, and shall be superseded by the contract specifications of the project.

\* Insert or select appropriate specifications.

### Scope

The contractor shall furnish all material and equipment required to satisfactorily complete the installation and jointing of the specified PowerPanel<sup>XL</sup> Intertency Wall Systems where indicated in the contract specification and/or on the layout drawings.

### Materials

All AAC material shall be Hebel PowerPanel<sup>XL</sup> as manufactured by Hebel.

All accompanying fixings shall be as per the current Hebel Low Rise Multi-Residential Intertency Walls Design & Installation Guide and/or the appropriate project consultant's specifications.

All lining materials shall be Gyprock<sup>TM</sup> plasterboard or Cemintel Fibre Cement sheet as manufactured and supplied by Building Products (or products of equivalent or better performance). Plasterboard shall be manufactured to meet the dimensional requirements of AS/NZS2588 'Gypsum Plasterboard'.

Steel frame components shall be those manufactured by Rondo Building Services Pty Ltd (or products of equivalent or better performance).

All infill material shall be Bradford<sup>TM</sup> infill as manufactured and/or supplied by Bradford (or products of equivalent or better performance).

### Wall System

The contractor shall supply and install \*PowerPanel<sup>XL</sup> Intertency Discontinuous Wall Systems, Option ..... or \*PowerPanel<sup>XL</sup> Intertency Non-discontinuous Wall Systems, Option ..... in accordance with the current Low Rise Intertency Design & Installation Guide HEB1288, and shall satisfy the following performance criteria.

The wall shall have a Fire Resistance Level \*FRL ...../...../..... in accordance with the requirements of AS1530.4.

Installation shall be carried out to the level specified for a field acoustic performance of \*Dntw/R'<sub>w</sub> ..... using cavity infill of \*Bradford..... (or products of equivalent or better performance).

### Lining Boards

The stud frame on each side of the Intertency shall be lined with one layer of \*.....mm Gyprock<sup>TM</sup> \*..... plasterboard, or one layer of \*.....mm Cemintel<sup>TM</sup> \*..... fibre cement sheet.

All layers shall be fixed and caulked as specified for the relevant system in the Gyprock<sup>TM</sup> Plasterboard Installation Manual, GYP547, other relevant technical literature, and Rondo Building Services literature or appropriate steel frame manufacturer's literature.

### Plasterboard Levels of Finish

All framing, plasterboard lining, jointing and finishing shall be carried out to \*Level .....Level of Finish, in accordance with Gyprock<sup>TM</sup> Plasterboard Installation Manual, GYP547 and/or AS/NZS2589.1 'Gypsum Linings in Residential and Light Commercial Construction – Application and Finishing'.

### Caulking

Provide a \* one or two sealant system in accordance with the sealant manufacturer's requirements. The sealant system shall be the polyurethane type and shall meet or exceed the fire resistance level (FRL) rating of the PowerPanel<sup>XL</sup> Intertency Wall Systems in which it is used.

In fire rated systems where caulking is indicated, use \*..... polyurethane fire and aoustic rated sealant with non fire-rated backing rod, installed in accordance with the manufacturer's recommendations or use \*..... polyurethane fire and aoustic rated sealant with fire-rated backing rod installed in accordance with the manufacturer's recommendations.

In non fire-rated or fire-rated wet areas where caulking is indicated, use fire rated \*..... polyurethane fire and aoustic rated sealant installed in accordance with the manufacturer's recommendations.

### Important

Any variation or substitution of materials or assembly requirements, or compromise in assembly may result in failure under critical conditions.

*NOTE: This information can be downloaded from the Hebel Website: [www.hebelastralia.com.au](http://www.hebelastralia.com.au)*

# Appendix C

## PowerPanel<sup>XL</sup> System Descriptions

HEB CODE	DESCRIPTION	WALL THICKNESS Stud Depth		FRL	R <sub>w</sub> /R <sub>w</sub> +C <sub>tr</sub> Stud Depth	
		70mm	90mm		70mm	90mm
HEB1900	Low Rise Multi-Residential Intertenancy Discontinuous Walls	275mm	315mm	-90/90	42/34	44/35
HEB1901	Low Rise Multi-Residential Intertenancy Discontinuous Walls	275mm	315mm		61/51	63/54
HEB1902	Low Rise Multi-Residential Intertenancy Discontinuous Walls	275mm	315mm	90/90/90	60/50	62/52
HEB1903	Low Rise Multi-Residential Intertenancy Discontinuous Walls	281mm	321mm	-90/90	43/34	45/36
HEB1904	Low Rise Multi-Residential Intertenancy Discontinuous Walls	281mm	321mm		64/52	67/55
HEB1905	Low Rise Multi-Residential Intertenancy Discontinuous Walls	281mm	321mm	90/90/90	63/50	66/53
HEB1906	Low Rise Multi-Residential Intertenancy Discontinuous Walls	281mm	321mm	-90/90	44/35	45/36
HEB1907	Low Rise Multi-Residential Intertenancy Discontinuous Walls	281mm	321mm		67/55	70/58
HEB1908	Low Rise Multi-Residential Intertenancy Discontinuous Walls	281mm	321mm	90/90/90	66/53	69/56
HEB1909	Low Rise Multi-Residential Intertenancy Discontinuous Walls	275mm	315mm	-90/90	43/34	45/36
HEB1910	Low Rise Multi-Residential Intertenancy Discontinuous Walls	275mm	315mm		64/52	67/55
HEB1911	Low Rise Multi-Residential Intertenancy Discontinuous Walls	275mm	315mm	90/90/90	63/50	66/53
HEB1912	Low Rise Multi-Residential Intertenancy Discontinuous Walls	273mm	313mm	-90/90	44/35	45/36
HEB1913	Low Rise Multi-Residential Intertenancy Discontinuous Walls	273mm	313mm		67/55	70/58
HEB1914	Low Rise Multi-Residential Intertenancy Discontinuous Walls	273mm	313mm	90/90/90	66/53	69/56
HEB1915	Low Rise Multi-Residential Intertenancy Non-Discontinuous Walls	285mm	325mm	-90/90	42/33	44/33
HEB1916	Low Rise Multi-Residential Intertenancy Non-Discontinuous Walls	285mm	325mm		59/46	61/46
HEB1917	Low Rise Multi-Residential Intertenancy Non-Discontinuous Walls	285mm	325mm	90/90/90	58/45	60/45
HEB1918	Low Rise Multi-Residential Intertenancy Non-Discontinuous Walls	291mm	331mm	-90/90	43/34	45/36
HEB1919	Low Rise Multi-Residential Intertenancy Non-Discontinuous Walls	291mm	331mm		61/47	62/48
HEB1920	Low Rise Multi-Residential Intertenancy Non-Discontinuous Walls	291mm	331mm	90/90/90	60/45	61/46
HEB1921	Low Rise Multi-Residential Intertenancy Non-Discontinuous Walls	291mm	331mm	-90/90	44/35	45/36
HEB1922	Low Rise Multi-Residential Intertenancy Non-Discontinuous Walls	291mm	331mm		58/49	59/50
HEB1923	Low Rise Multi-Residential Intertenancy Non-Discontinuous Walls	291mm	331mm	90/90/90	57/47	58/48
HEB1924	Low Rise Multi-Residential Intertenancy Non-Discontinuous Walls	285mm	325mm	-90/90	43/34	45/36
HEB1925	Low Rise Multi-Residential Intertenancy Non-Discontinuous Walls	285mm	325mm		61/47	62/48
HEB1926	Low Rise Multi-Residential Intertenancy Non-Discontinuous Walls	285mm	325mm	90/90/90	60/45	61/46
HEB1927	Low Rise Multi-Residential Intertenancy Non-Discontinuous Walls	283mm	323mm	-90/90	44/35	45/36
HEB1928	Low Rise Multi-Residential Intertenancy Non-Discontinuous Walls	283mm	323mm		58/49	59/50
HEB1929	Low Rise Multi-Residential Intertenancy Non-Discontinuous Walls	283mm	323mm	90/90/90	57/47	58/48



## The better way to build

CSR HEBEL  
112 Wisemans Ferry Road  
Somersby NSW 2250  
Fax (02) 4340 3300

### Health & Safety

Information on any known health risks of our products and how to handle them safely is on their packaging and/or the documentation accompanying them. Additional information is listed in the Material Safety Data Sheet (MSDS). To obtain a copy of a MSDS, telephone 1800 807 668 or download from [www.hebelaustralia.com.au](http://www.hebelaustralia.com.au). Contractors are required by law to perform their own risk assessments before undertaking work. Hebel has sample Safe Work Method Statements (SWMS) to assist in this. To obtain a sample SWMS, refer also to the above sources.

### Performance & Certification

Hebel® products are manufactured in Australia by CSR Building Products.

A.B.N. 55 008 631 356. It is a manufacturer and supplier of Hebel Autoclaved Aerated Concrete (AAC) products. Because it is a manufacturer and supplier only, CSR does not employ people qualified as Accredited or Principal Certifiers. CSR is therefore unable to provide Construction Compliance Certificates or Statements of Compliance. CSR conducts appropriate testing of its products and systems to determine performance levels. These include structural, fire and acoustic tests. Testing is conducted and certified by appropriate specialists in these fields. When using Hebel products and systems in specific projects, such specialists should be consulted to ensure compliance with the Building Code of Australia and relevant Australian Standards.

### Other

The design of a wall, floor or fence system requires the services of professional consultants. This Design Guide has been prepared as a source of information to provide general guidance to those consultants – and in no way replaces the services of the professional consultant and relevant engineers designing the project.

No liability can therefore be accepted by CSR or other parties for the use of this Design Guide. Hebel products and systems undergo constant research and development to integrate new technology and reflect ongoing performance enhancement.

Hebel systems are also constantly reviewed so as to reflect any changes in legislative building requirements and or general developments in common building practice. Due to our commitment to continual development and improving our building systems.

We advise that all users of this manual: HELIT013Jun14 should regularly check that this manual is current, and they are applying our latest design information.

The latest editions of our Design Guides and supplementary diagrams and technical data are always available on our website: [www.hebelaustralia.com.au](http://www.hebelaustralia.com.au)

Hebel® is a registered trademark of the Xella group. CSR Hebel is an exclusive licensee of Xella and a division of CSR Building Materials Ltd. CSR, PowerPanelXL®, Hebel Block®, PowerFloor®, Hebel Floor®, PowerFence®, PowerBase®, HighBuild®, are registered trademarks of CSR Building Products Limited.

## The better way to build

Hebel is a quality building product, and is backed by CSR Building Products Limited.

Further details on engineering and building with Hebel systems are available in the Hebel Design Guides and Technical Manual. To obtain a copy, or for further sales or technical assistance, please visit our website.

**Hebel website:**  
**[www.hebelaustralia.com.au](http://www.hebelaustralia.com.au)**

For sales enquiries or further information, please telephone us from anywhere in Australia:

# 1300 369 448

### Warranty

Hebel continues to lead the market with premium quality products, which are the preferred choice of many building professionals. All CSR products are designed to achieve optimal performance when installed in accordance with published Design and Installation Guides using recommended products, accessories and other components. For details of product and system warranties provided by Hebel, contact a CSR Hebel representative on 1300 369 448 or visit [www.hebelaustralia.com.au](http://www.hebelaustralia.com.au).

### Disclaimer

The information presented herein is supplied in good faith and to the best of our knowledge was accurate at the time of preparation. The provision of this information should not be construed as a recommendation to use any of our products in violation of any patent rights or in breach of any statute or regulation. Users are advised to make their own determination as to the suitability of this information in relation to their particular purpose or specific circumstances. Since the information contained in this document may be applied under conditions beyond our control, no responsibility can be accepted by Hebel, or its staff for any loss or damage caused by any person acting or refraining from action as a result of misuse of this information.

**HELIT013Jun14**

Available from: